

Una

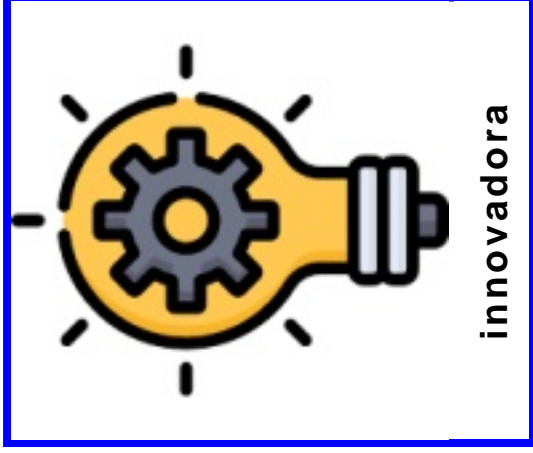

mujer



innovadora

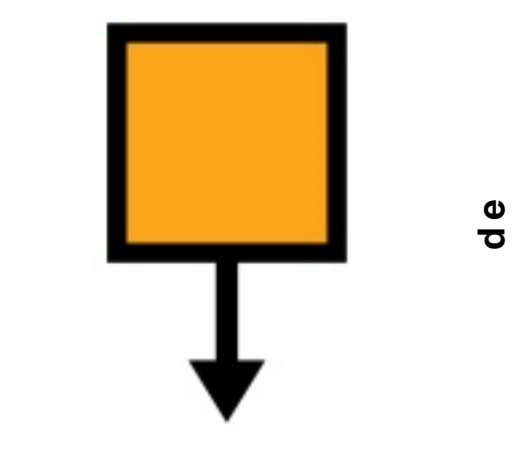
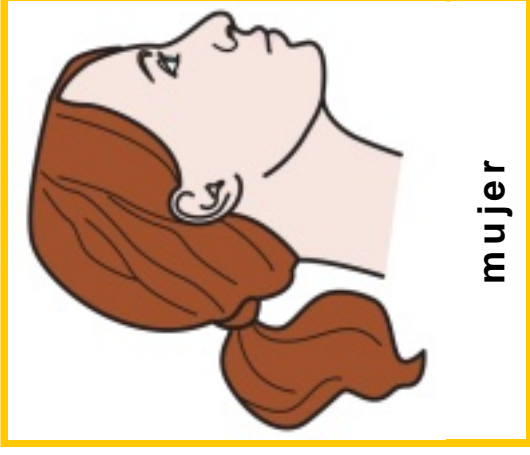
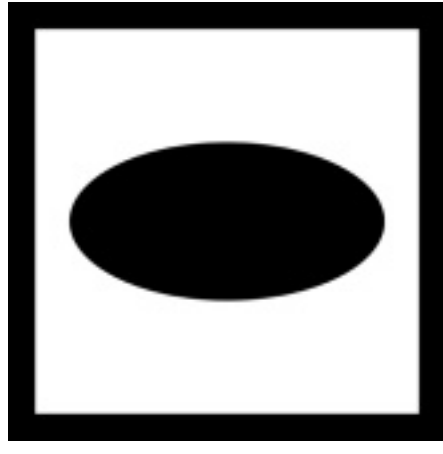
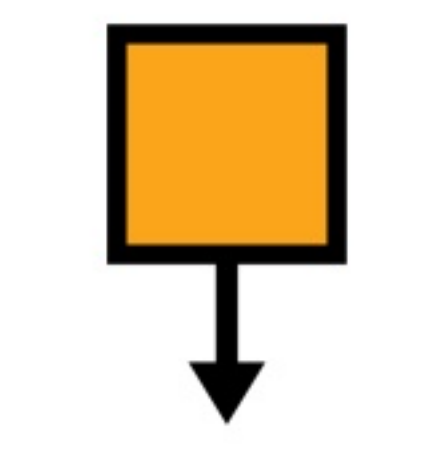
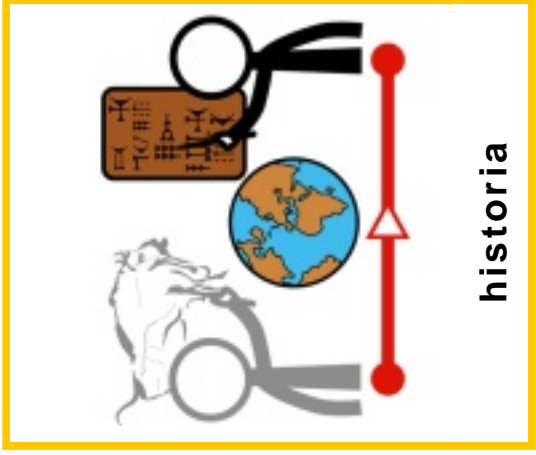
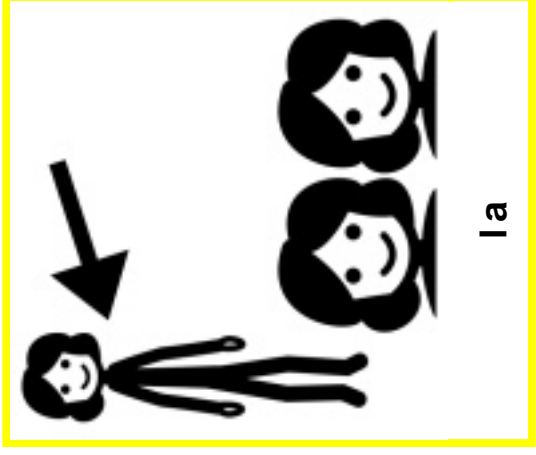
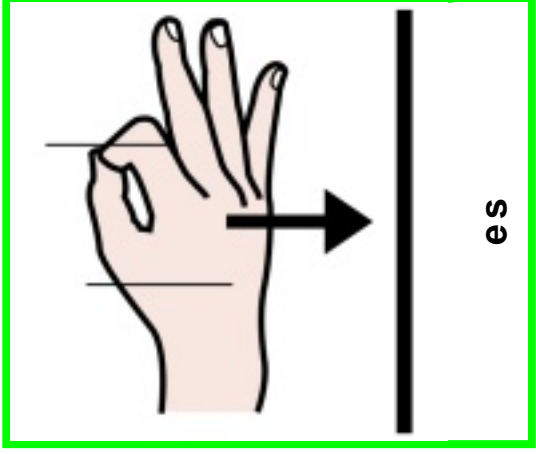
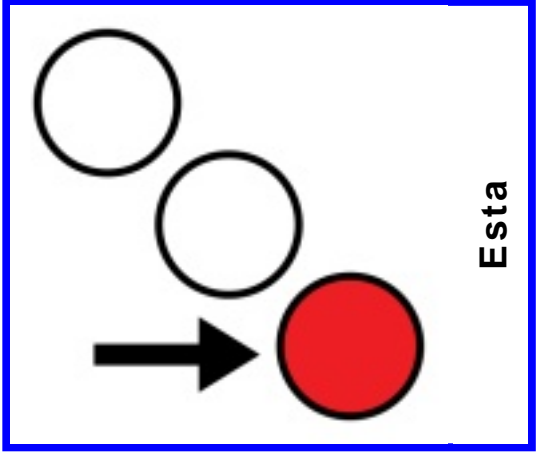

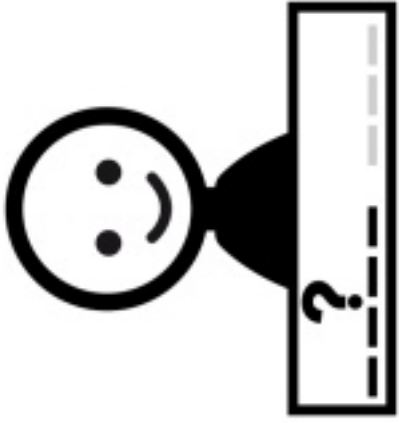

nombre

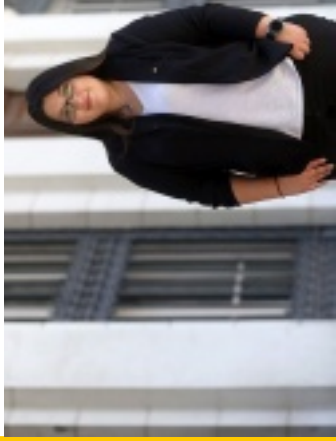

Barbarita Lara



Barbarita Lara

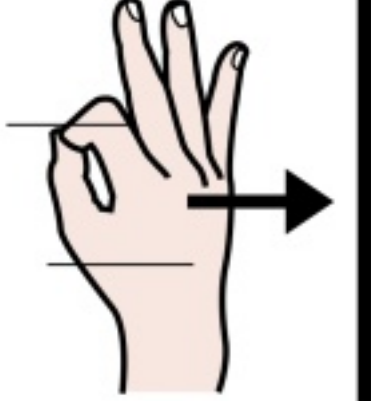

es

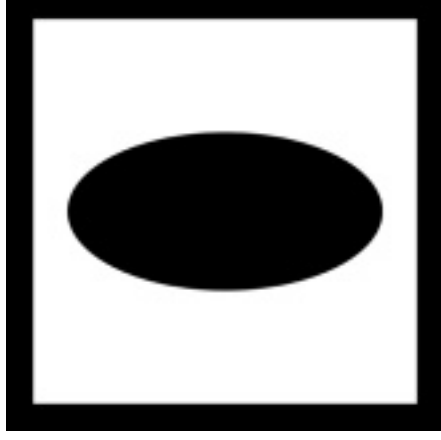

una



mujer

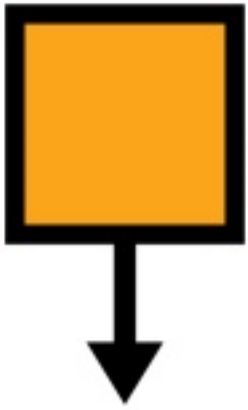

de



que

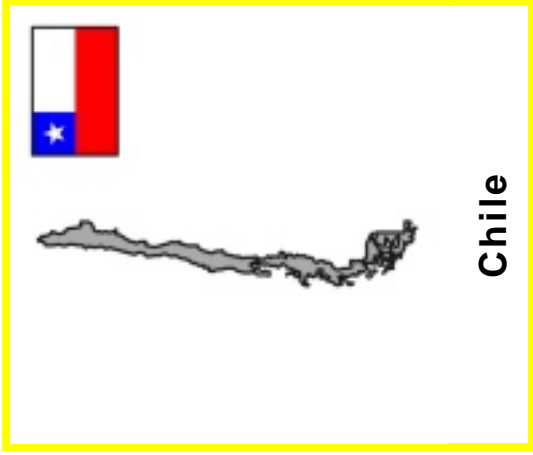

Chile

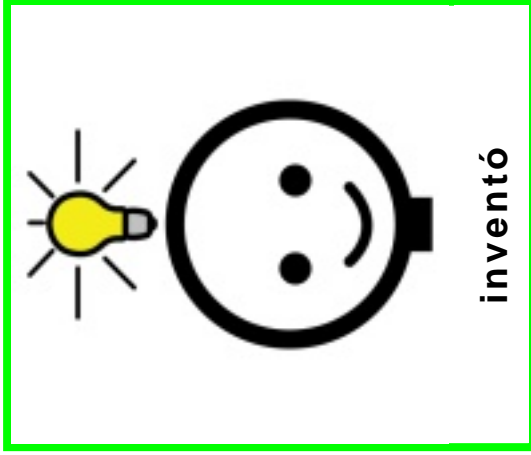

inventó

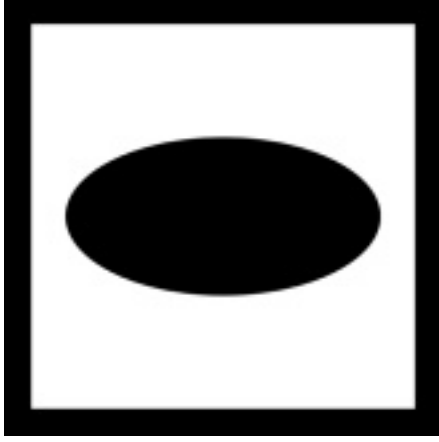

una

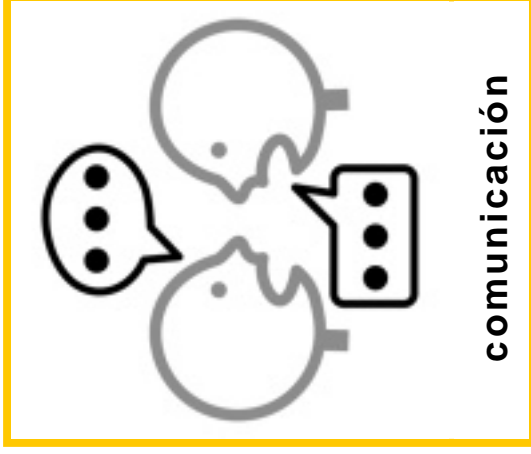

comunicación

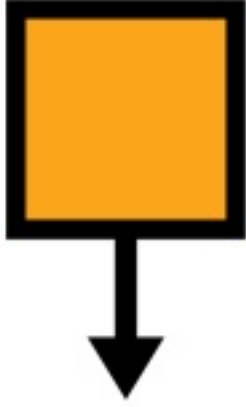
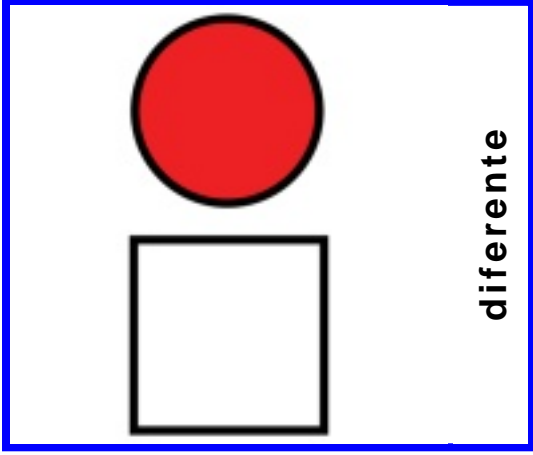

de

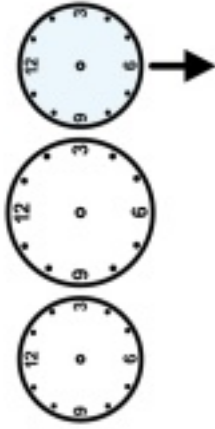

después

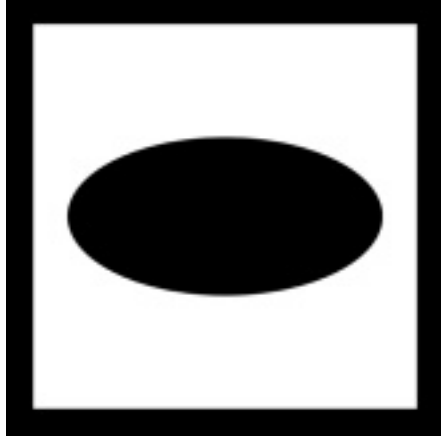

un



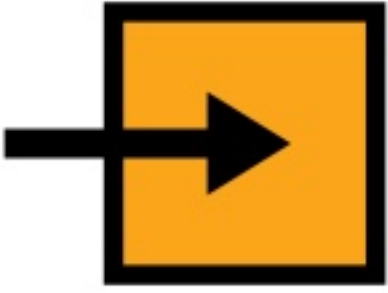

en

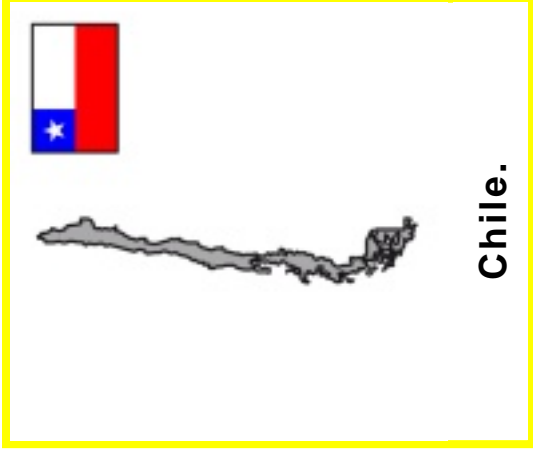

Chile.



el

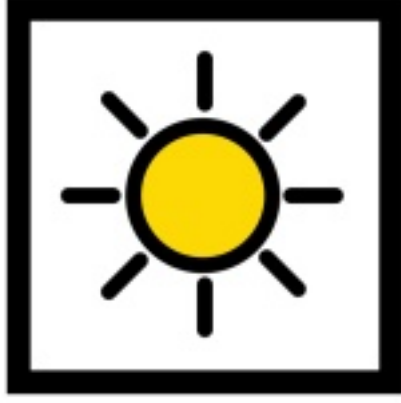

día

27



de

27



febrero



del

2010

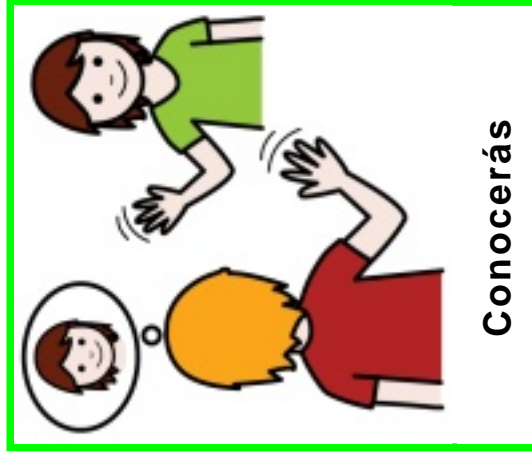

Conocerás



el

2010

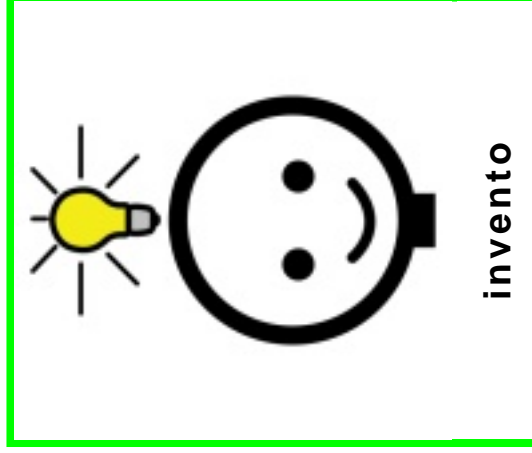

invento



que



hizo



Barbarita Lara

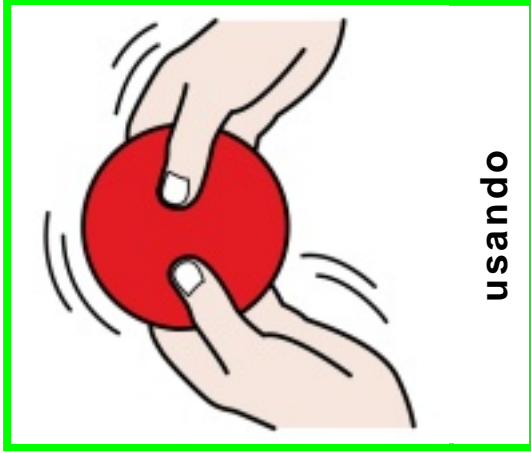

usando

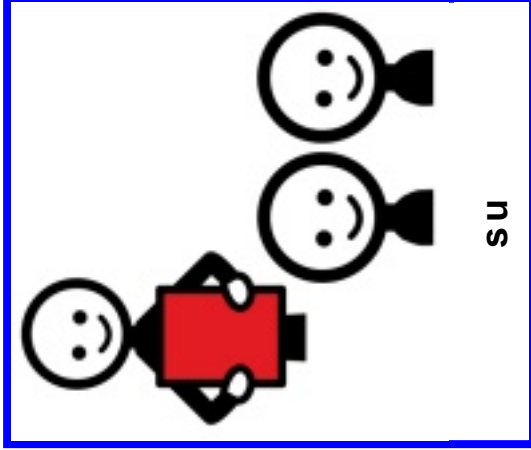

su

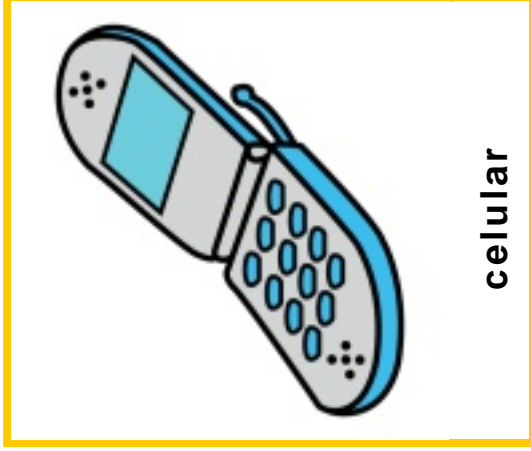

celular



para

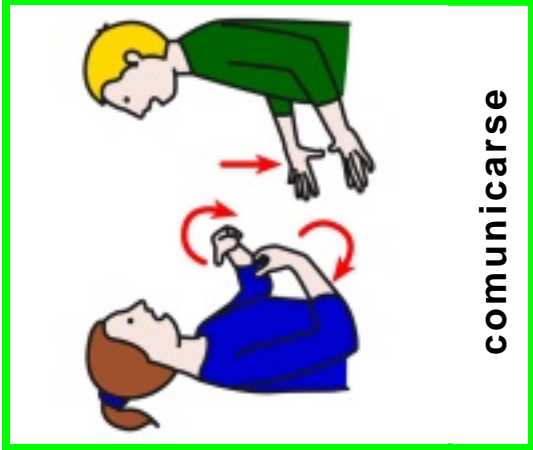

comunicarse

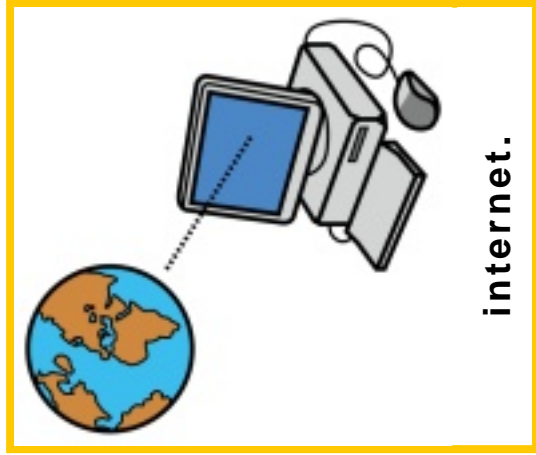

internet.



sin

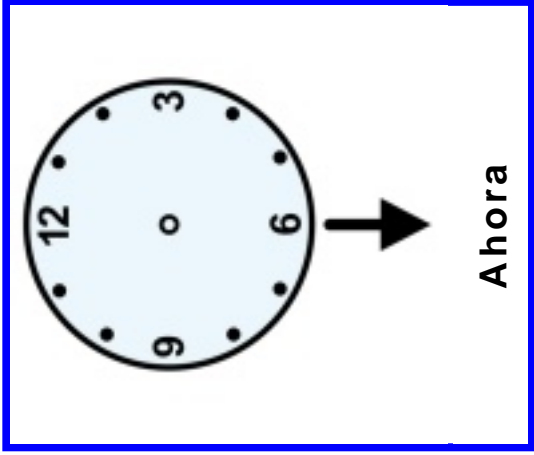

Ahora

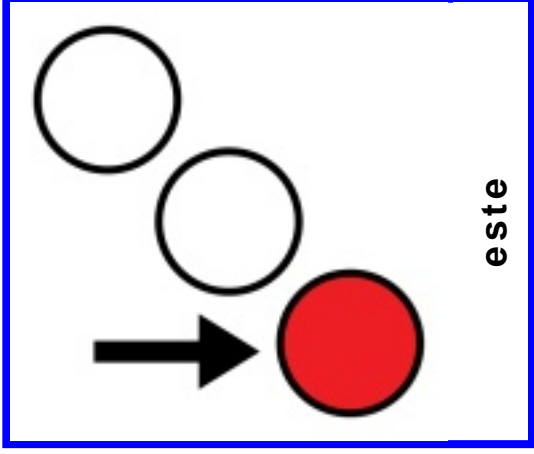

este

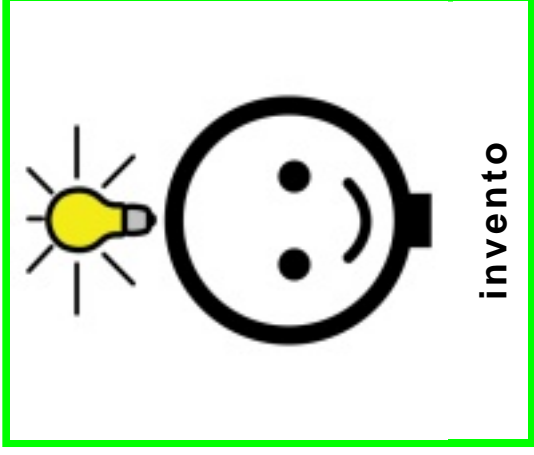

invento

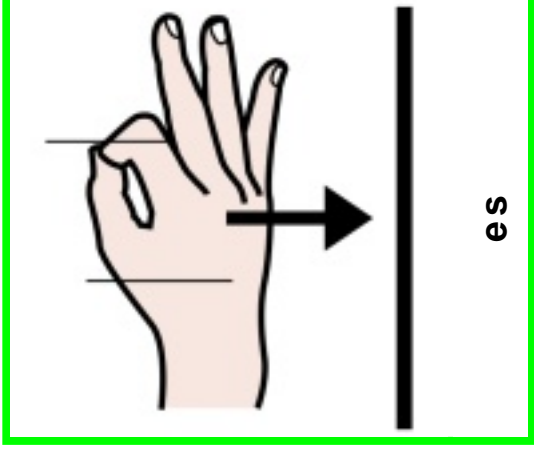

es

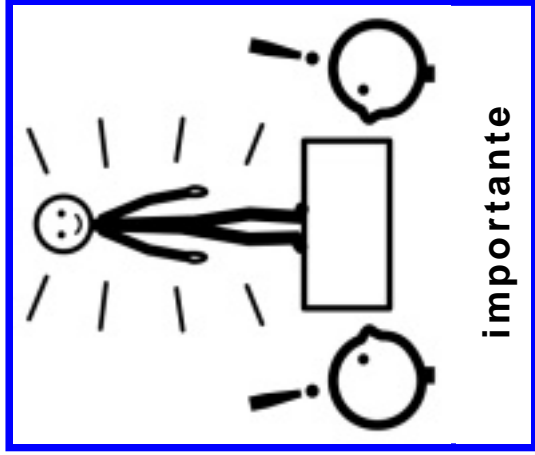

importante



para

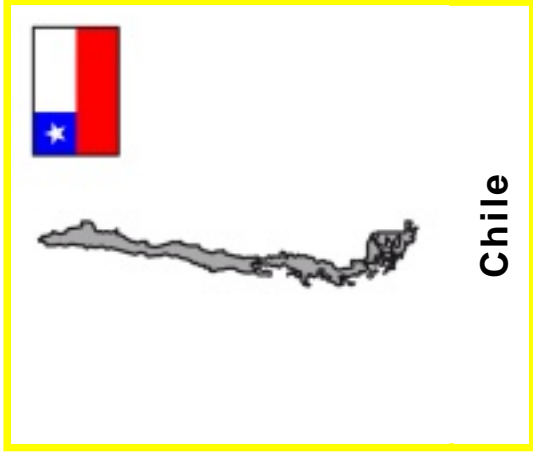

Chile

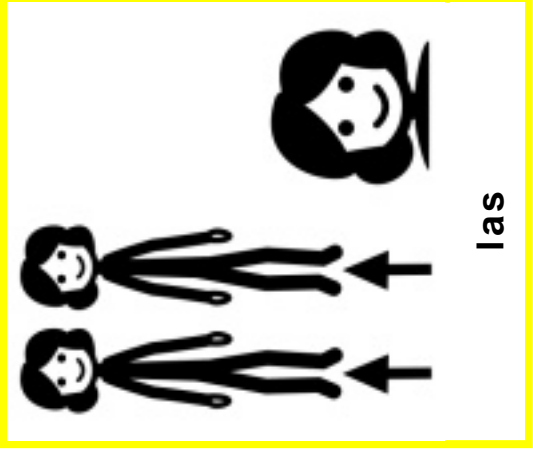

las



personas

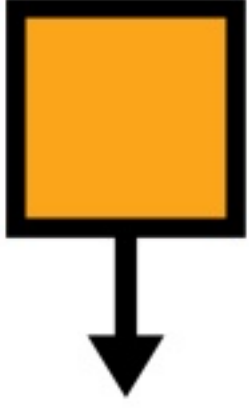

de



para



tu



ti



familia



y

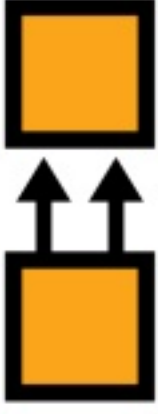

para

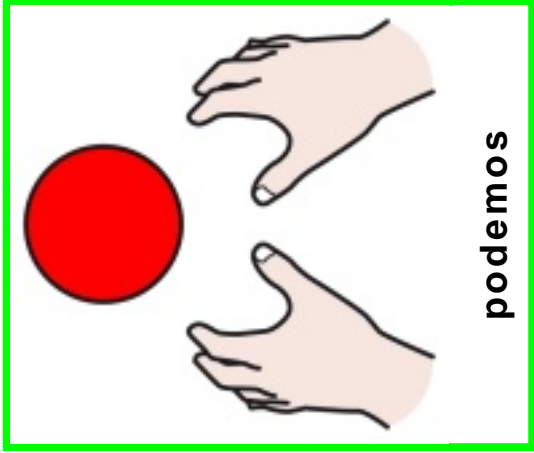
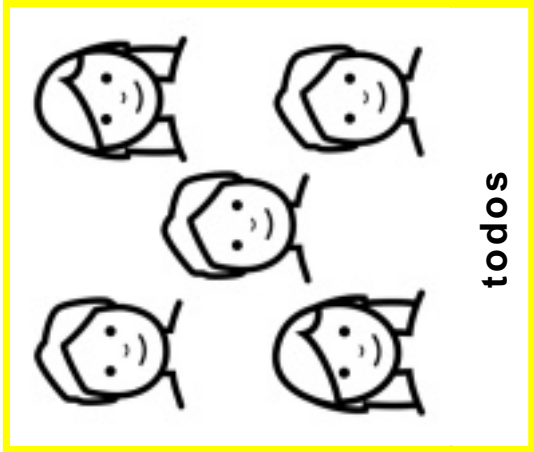
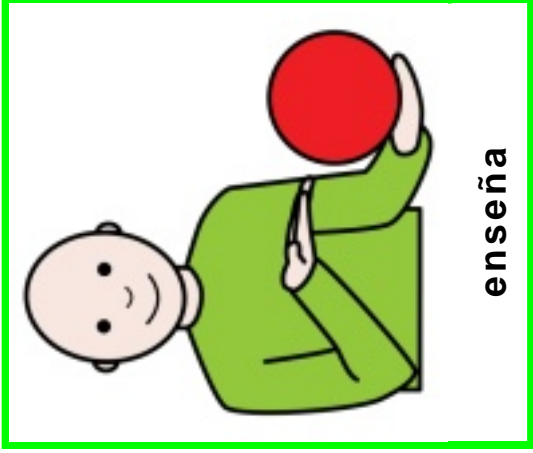
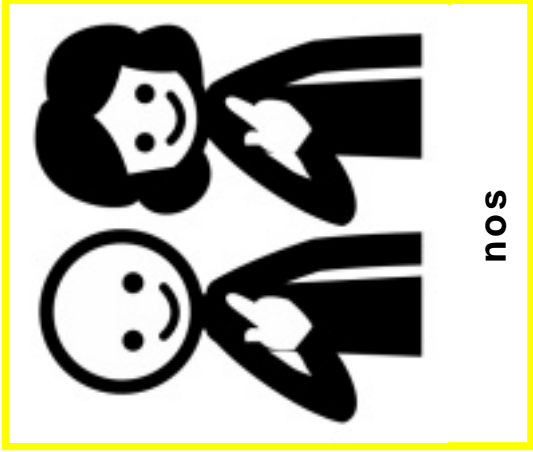

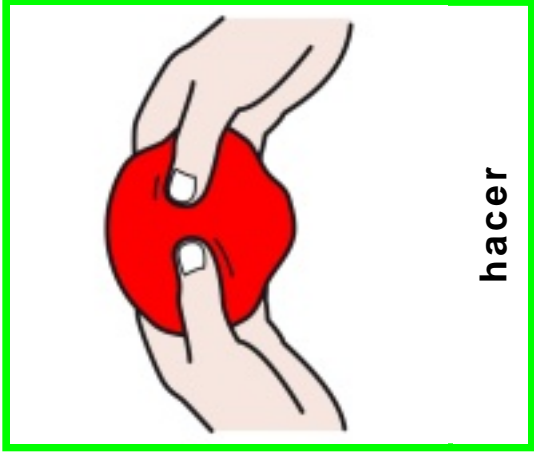

hacer

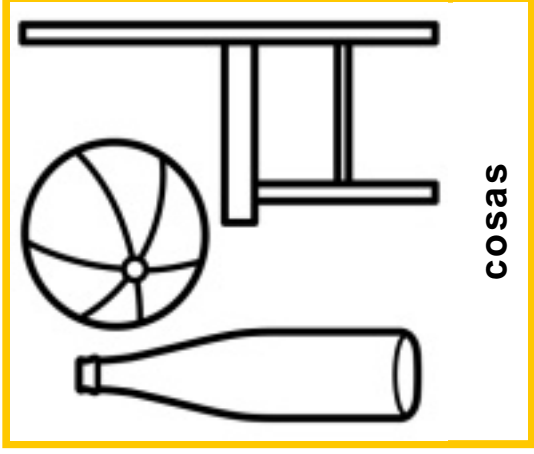

cosas

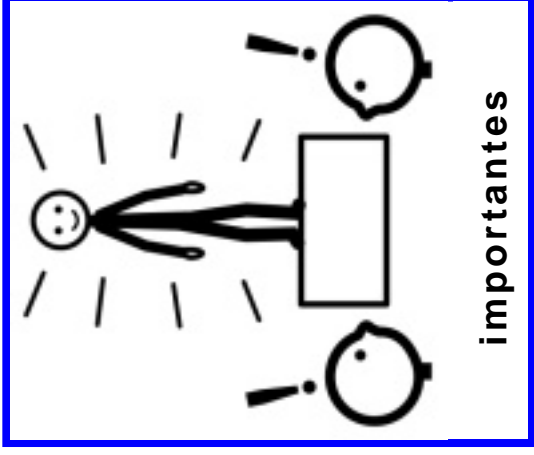

importantes

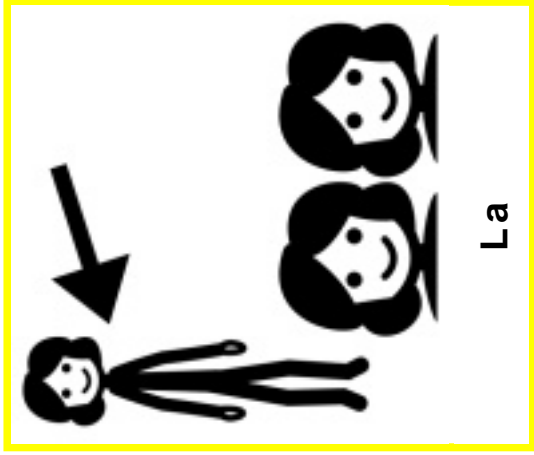

La

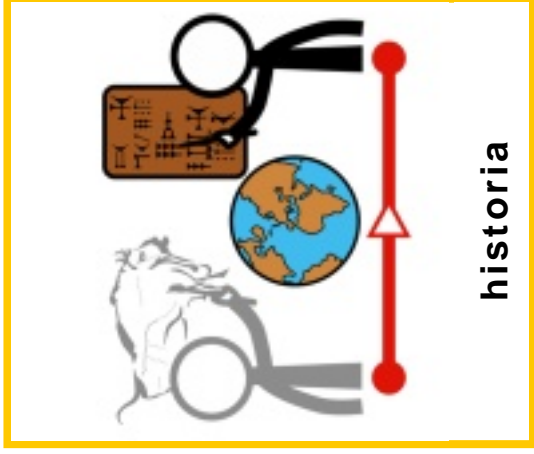

historia

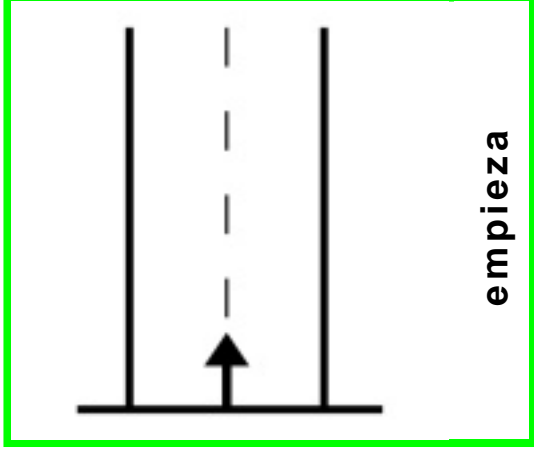

empieza

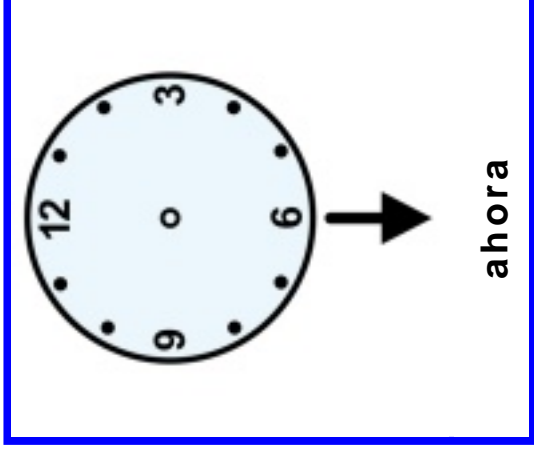

ahora

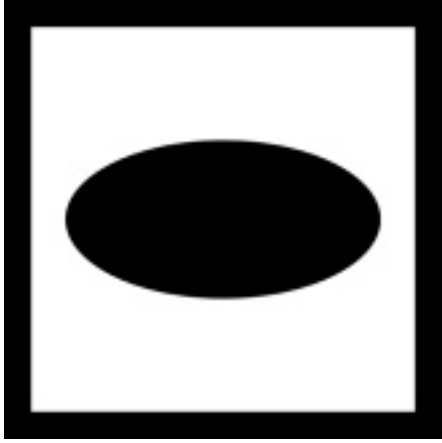

Una

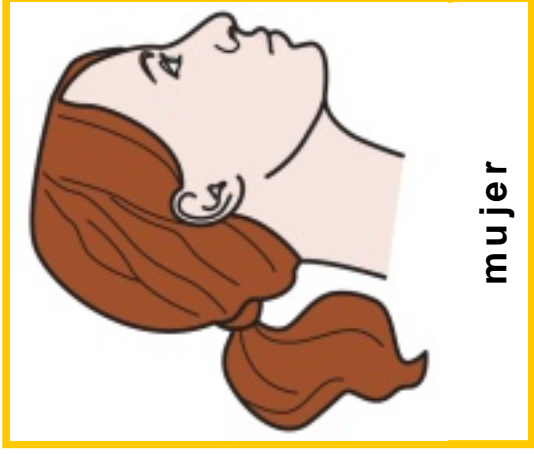

mujer

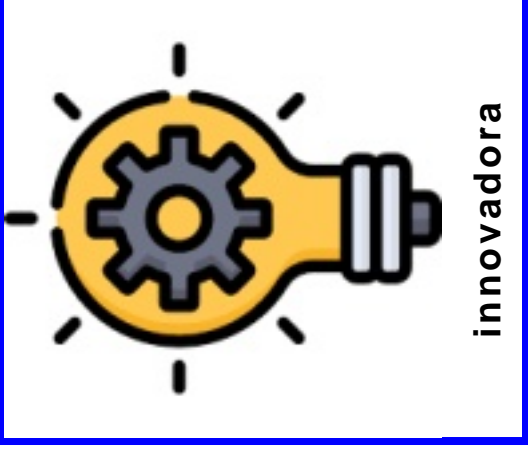

innovadora



Barbarita Lara

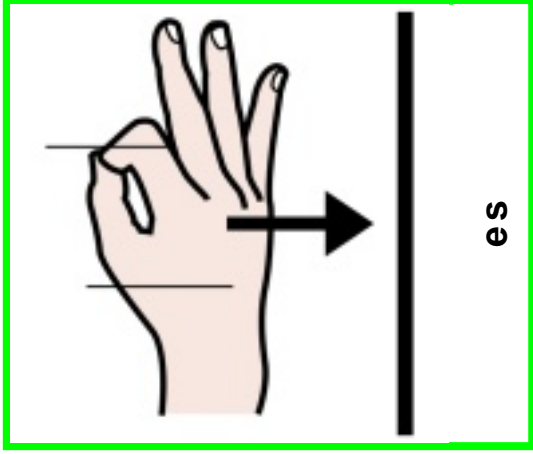

es

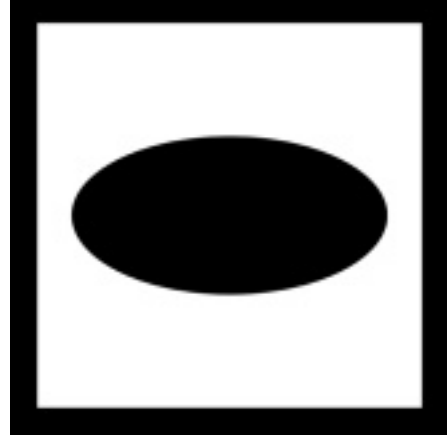

una

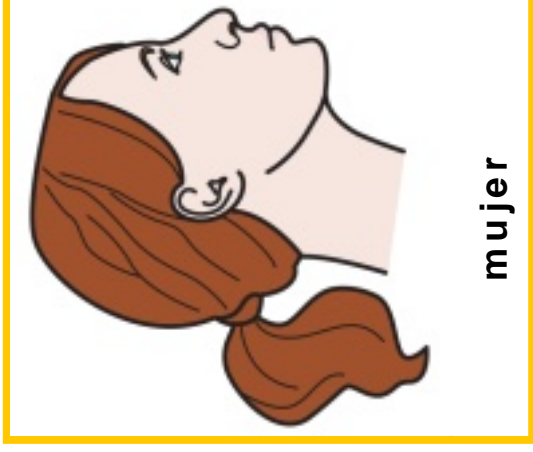

mujer



de

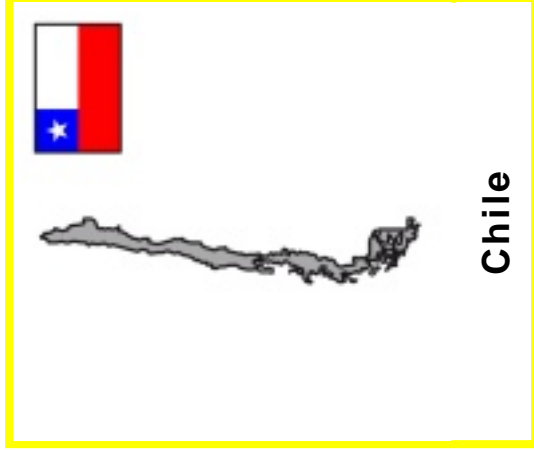

Chile

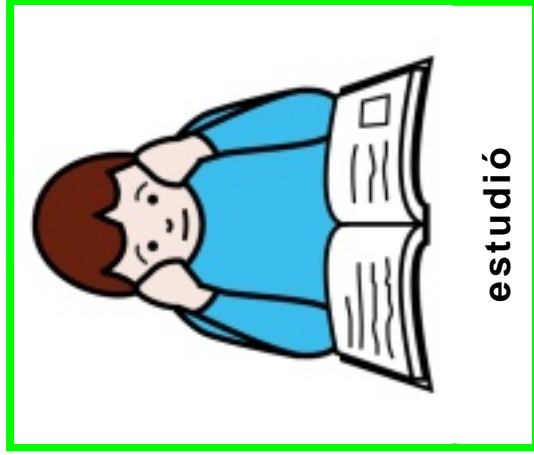

estudió



para

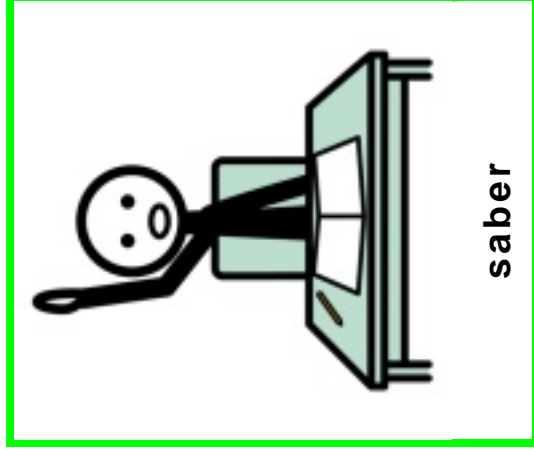

saber



usar



tecnología

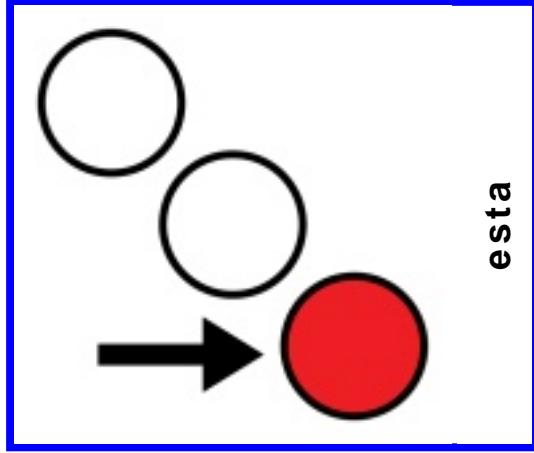

esta



profesión

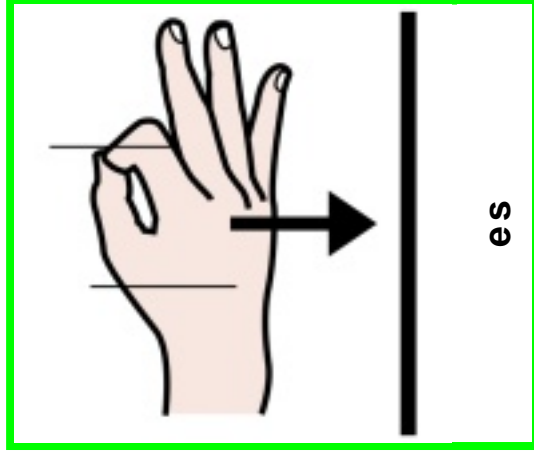

es

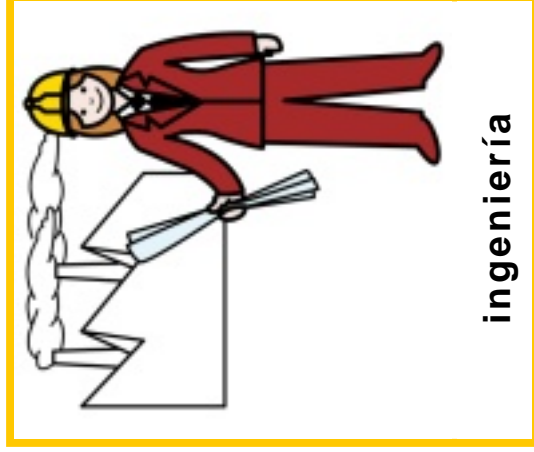

ingeniería

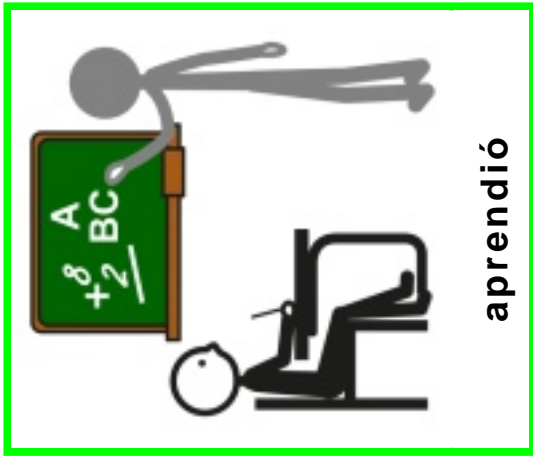
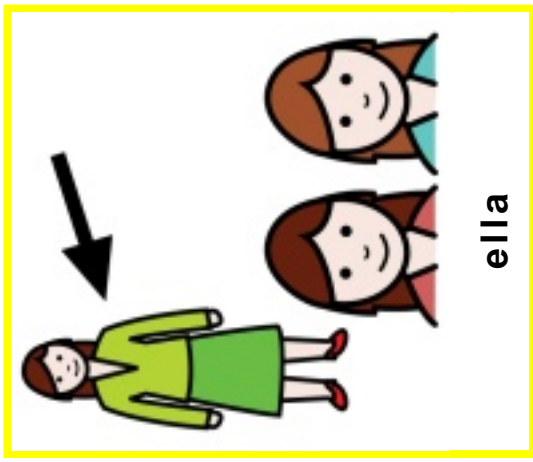
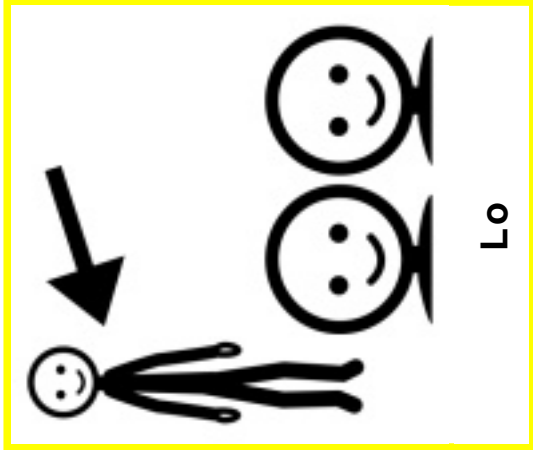

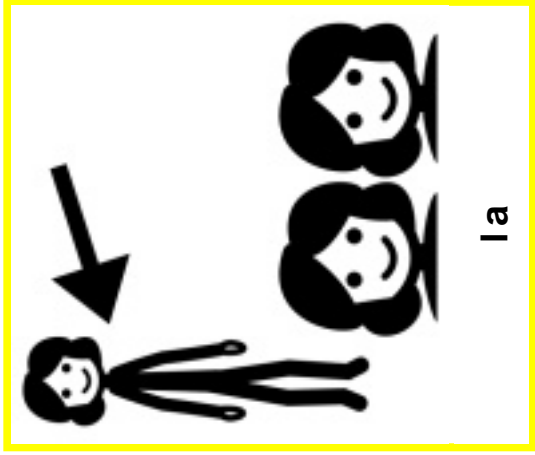

la

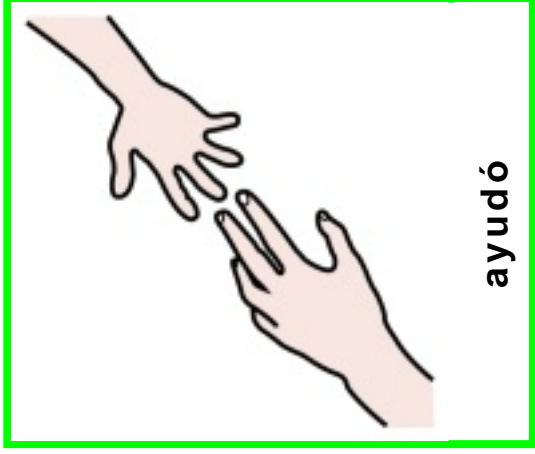

ayudó



a

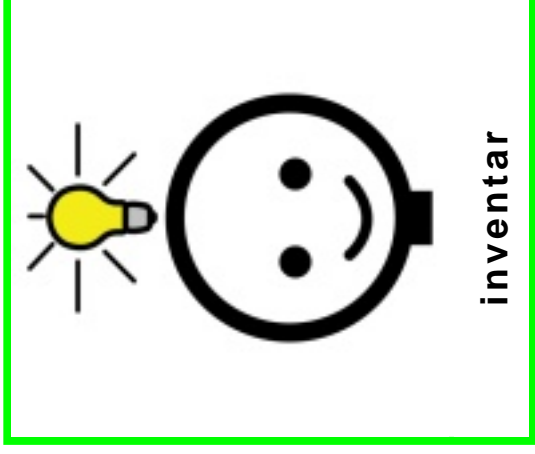

inventar

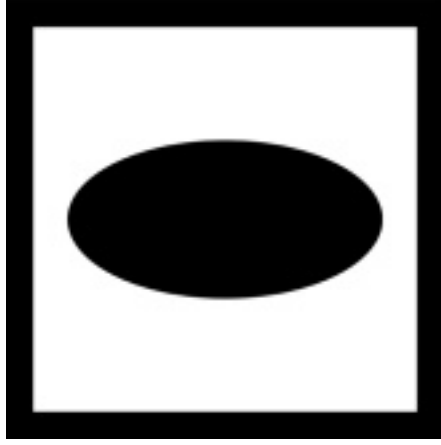

una

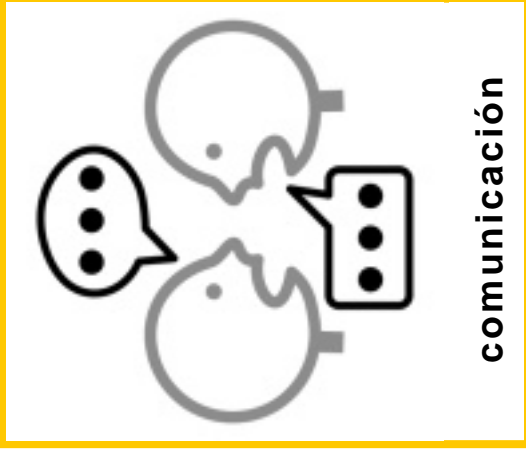

comunicación



del

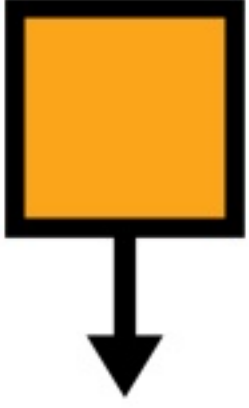

de

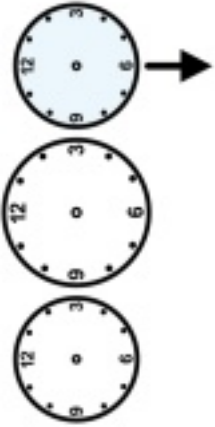

después

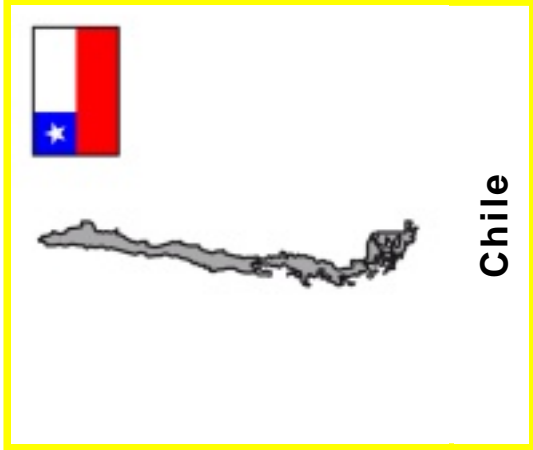

Chile



terremoto



el



El

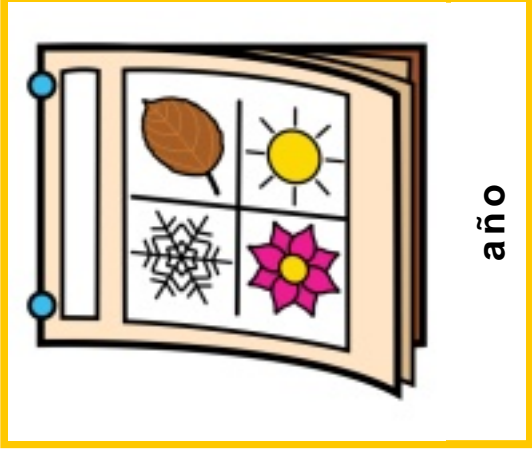

2010

año

2010

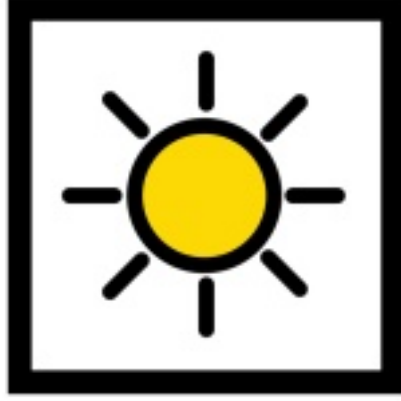

día



del



terremoto

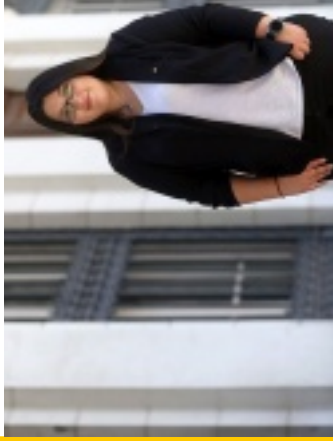

Barbarita Lara

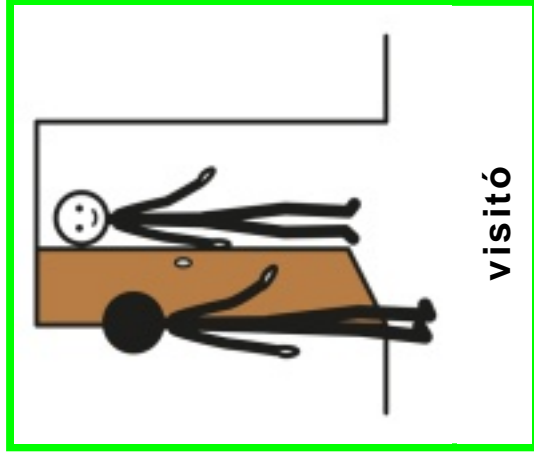

visitó

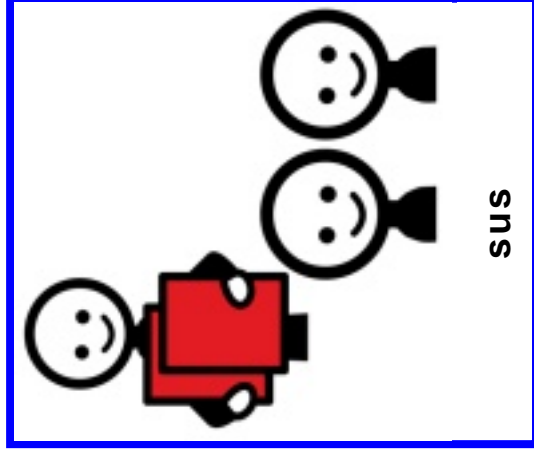

sus

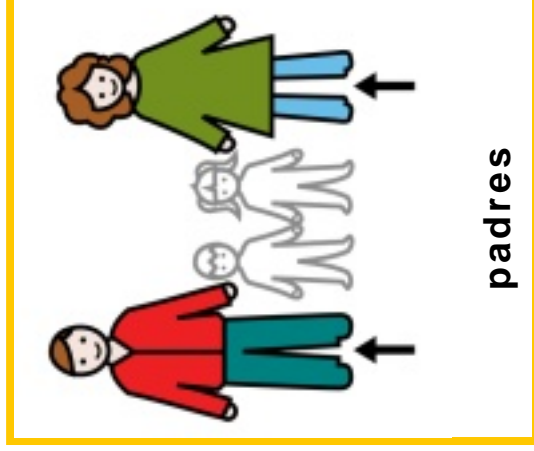

padres



con

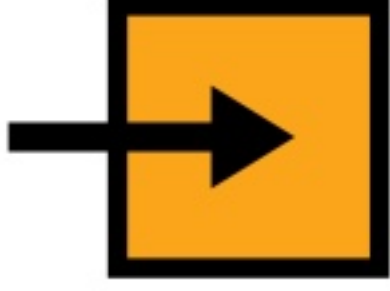
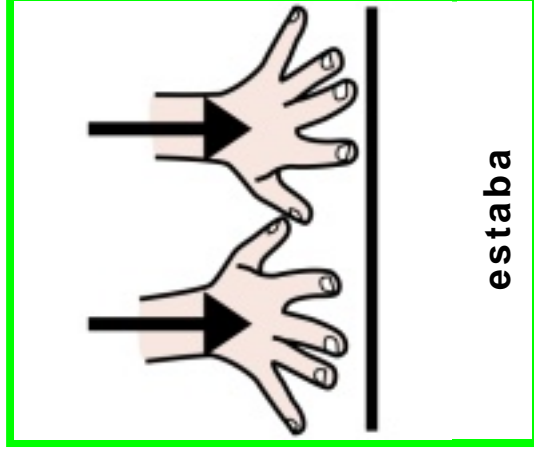
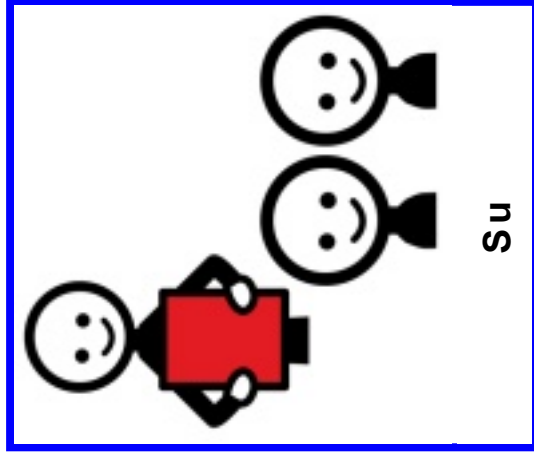
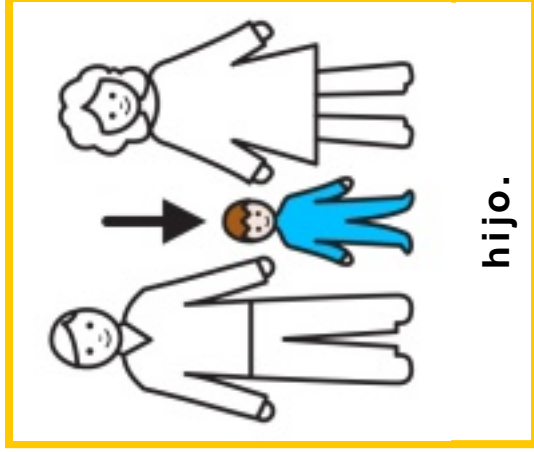
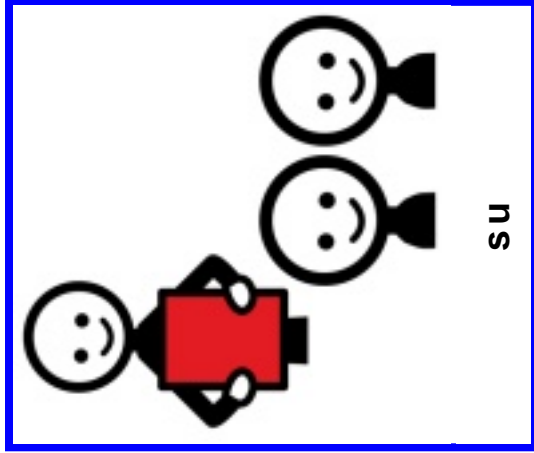

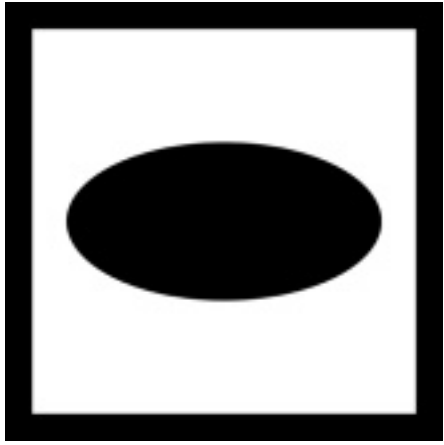

un

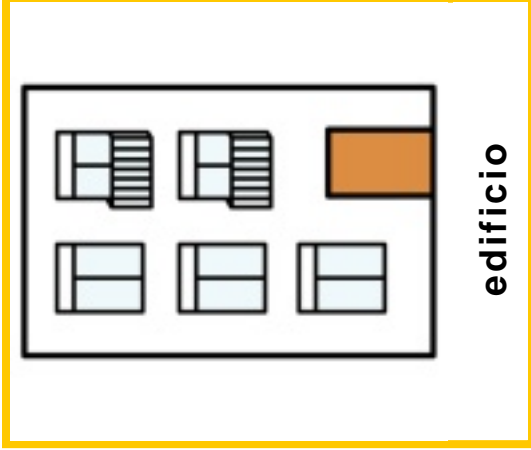

edificio

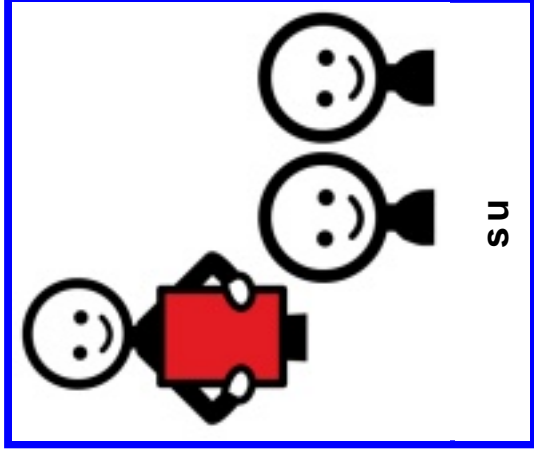

su



esposo

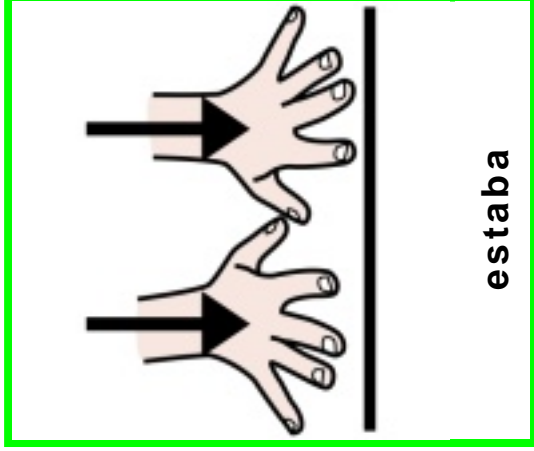

estaba

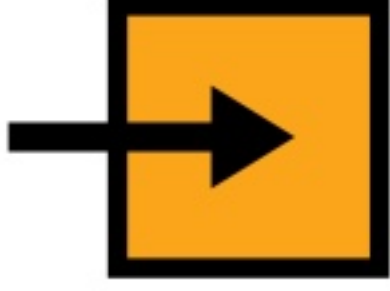

en



el

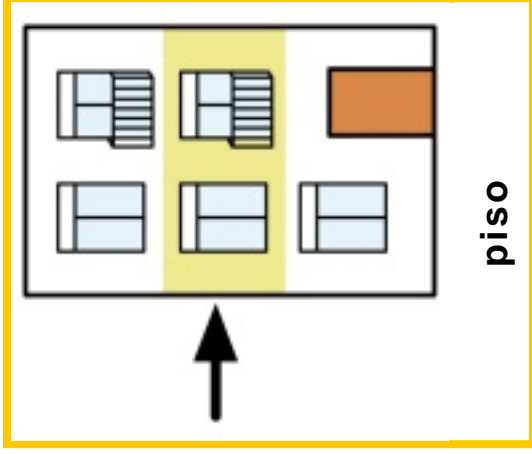

piso

9

nueve.



Barbarita Lara

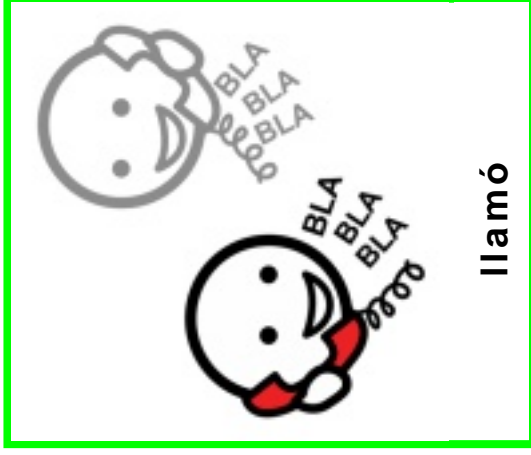

llamó



por



celular



a



y

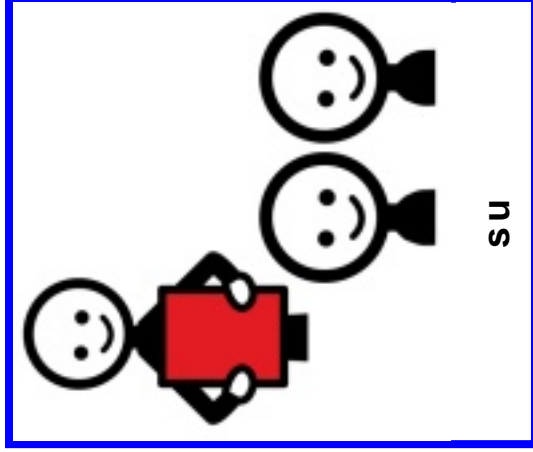

su

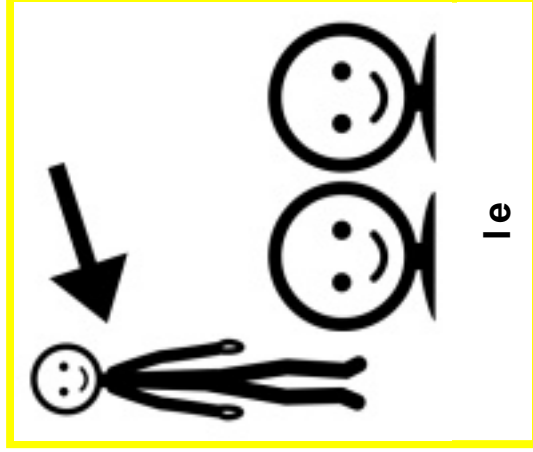

le



esposo

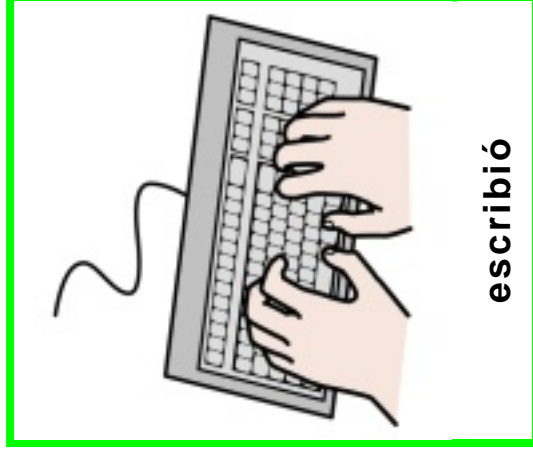

escribió



mensaje de texto



pero



no

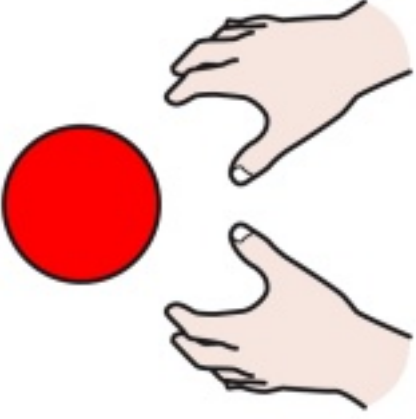

pudo

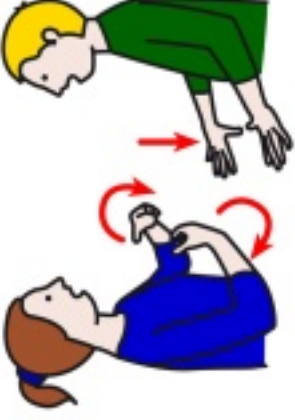

comunicarse



porque



mal

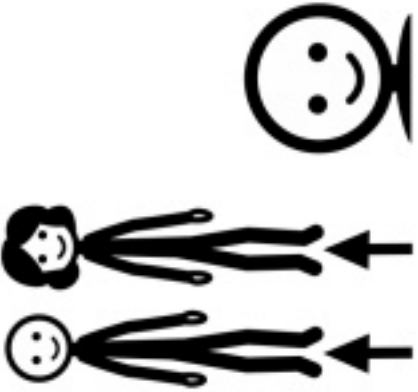

los



celulares

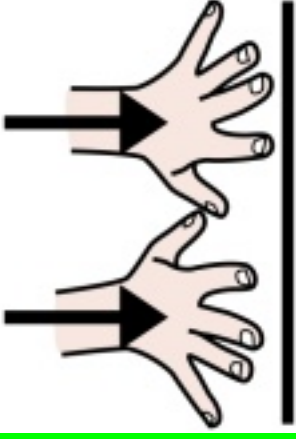

estaban



el

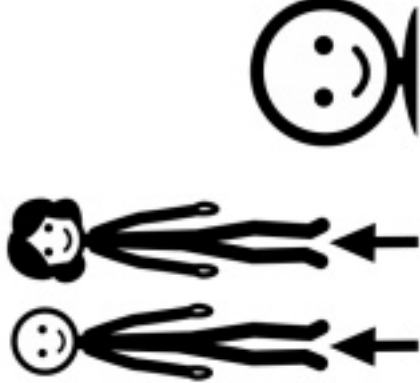

los



terremoto

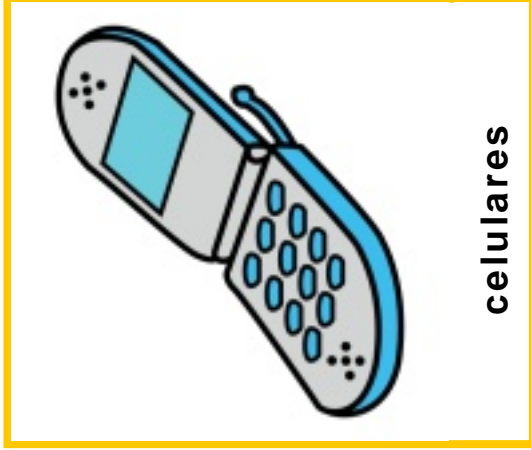

celulares

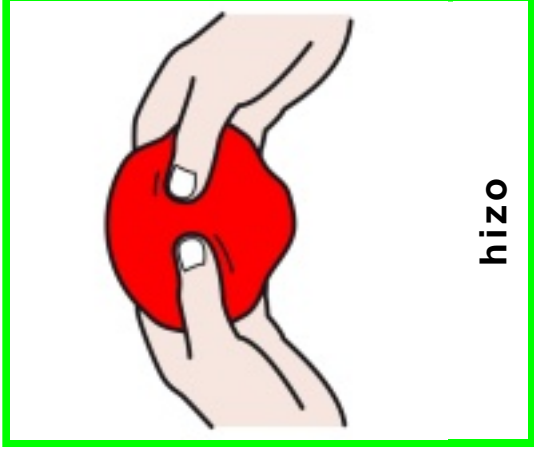

hizo



que

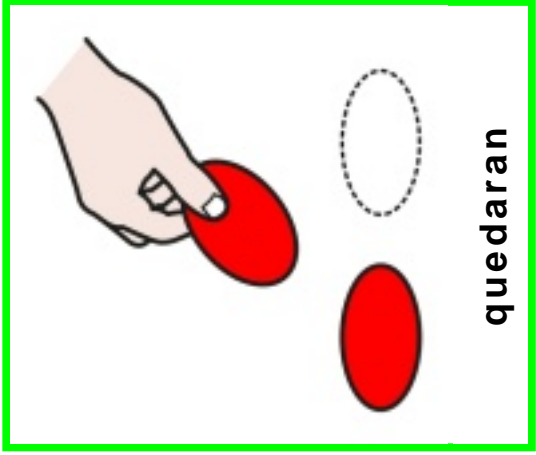

quedaran



sin

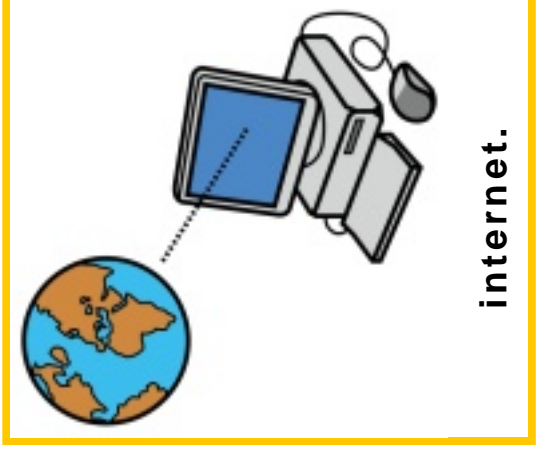

internet.



Barbarita Lara

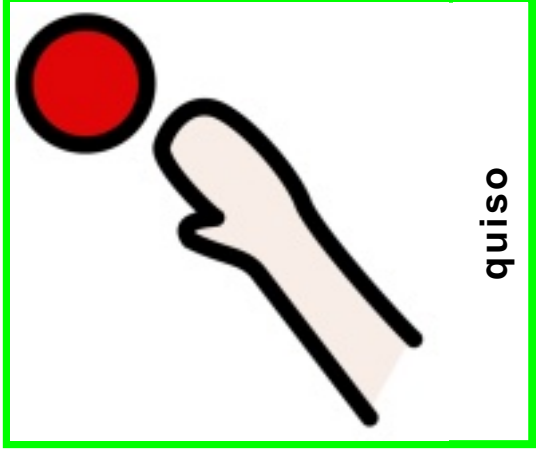

quiso

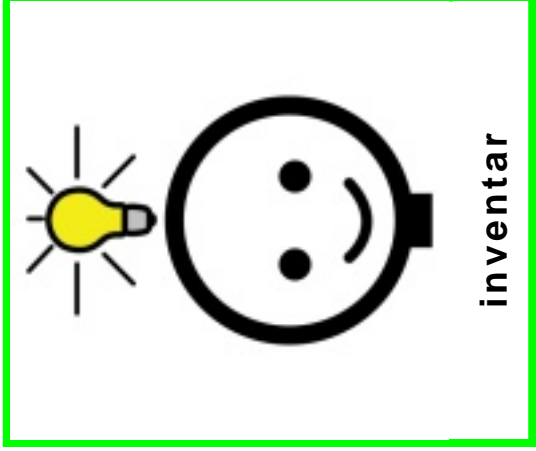

inventar

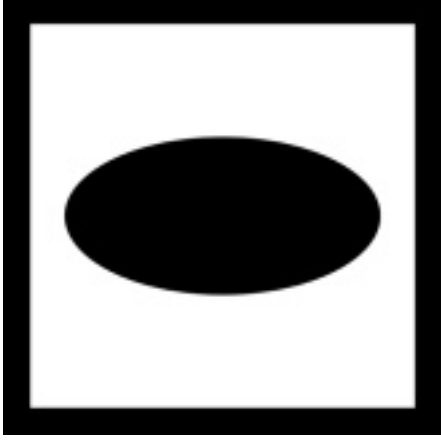

una

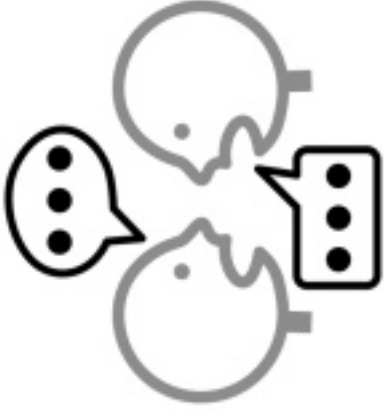

comunicación



usando



celulares



sin



internet.



EI

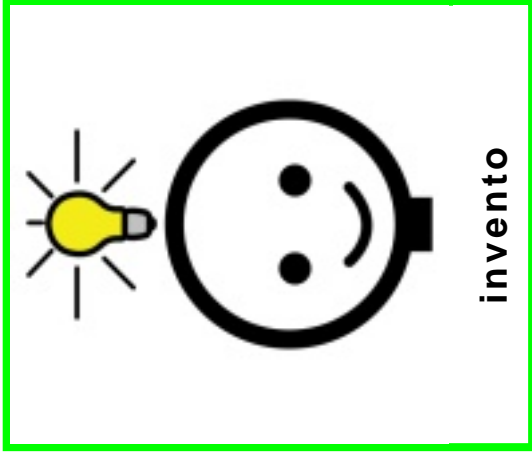

invento

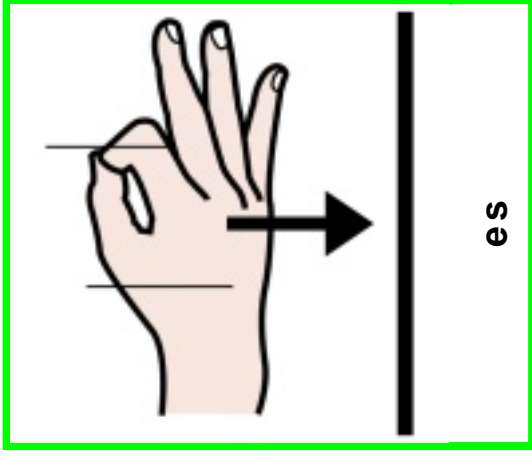

es



el



Sistema de Información de Emergenci:

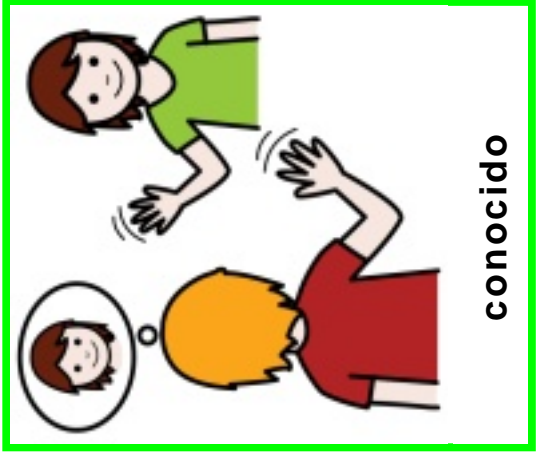

conocido

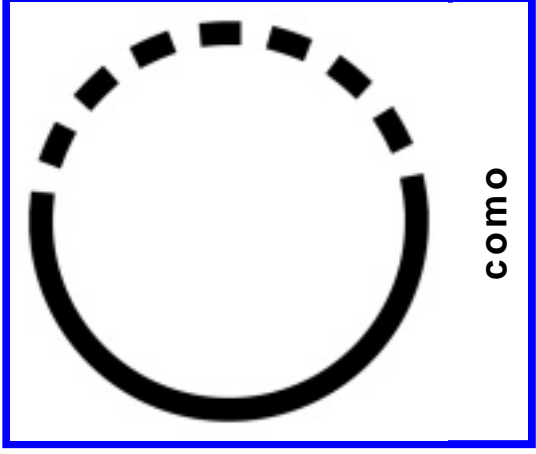

como

SIE

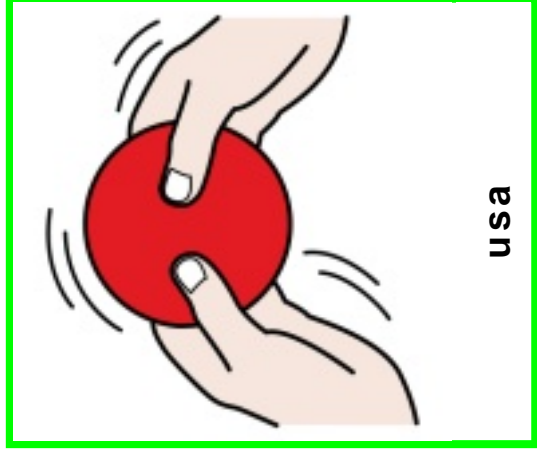

usa

SIE

SIE

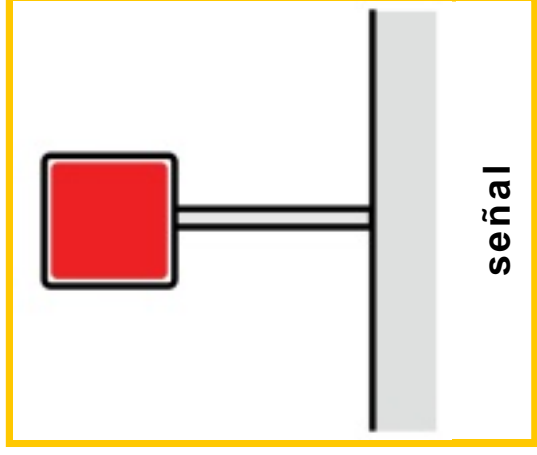

señal

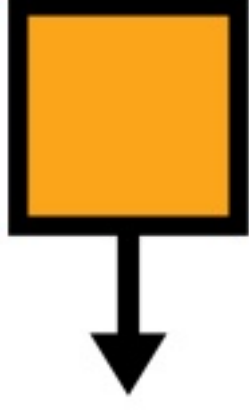

de

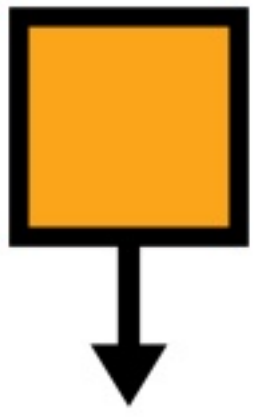
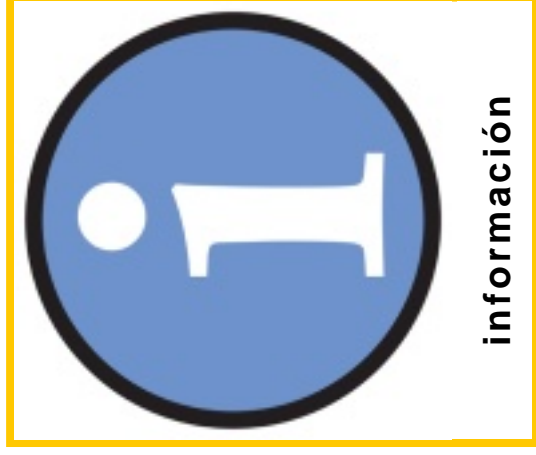
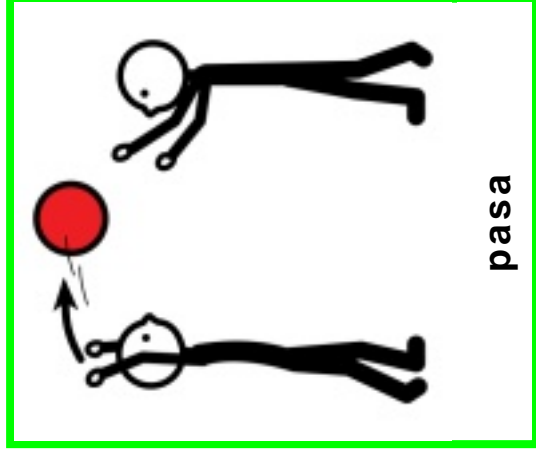
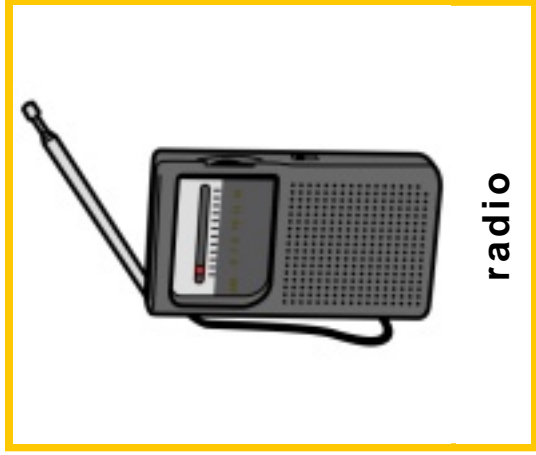

de

información

pasa

que

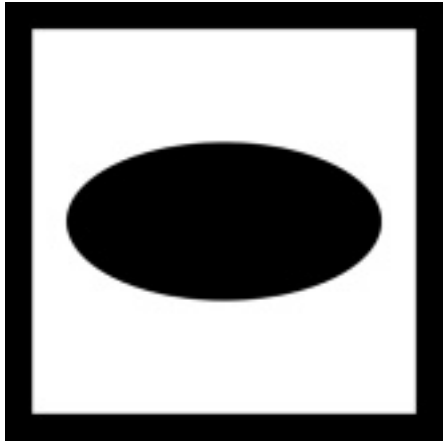

un



a

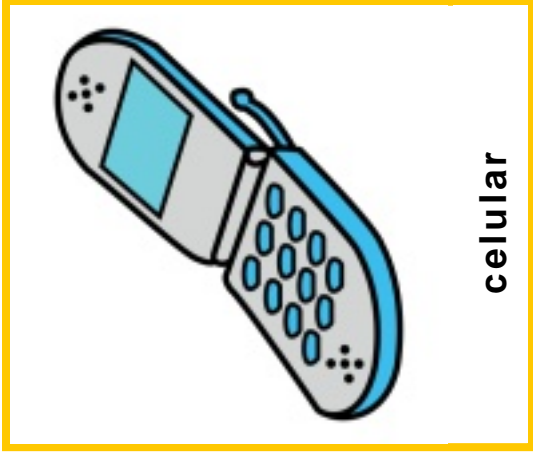

celular

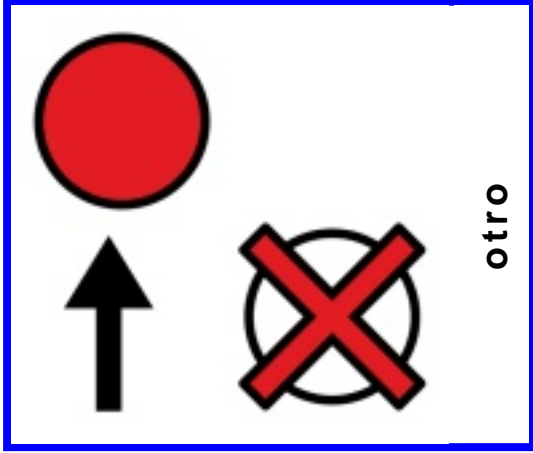

otro

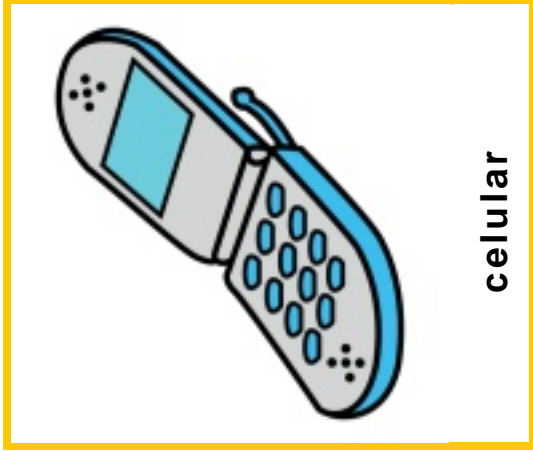

celular

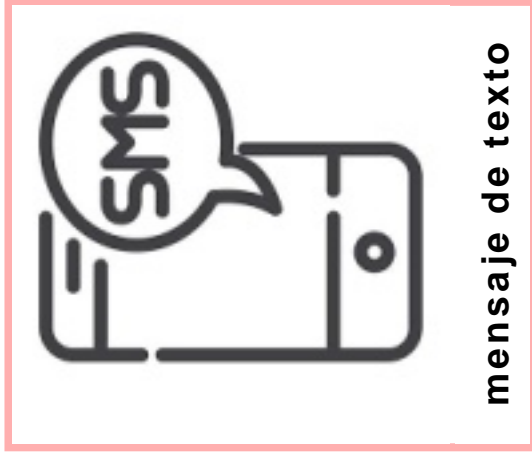
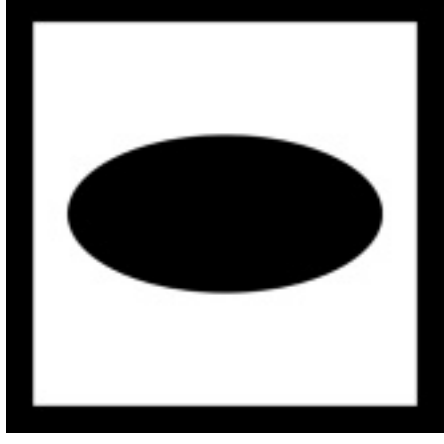
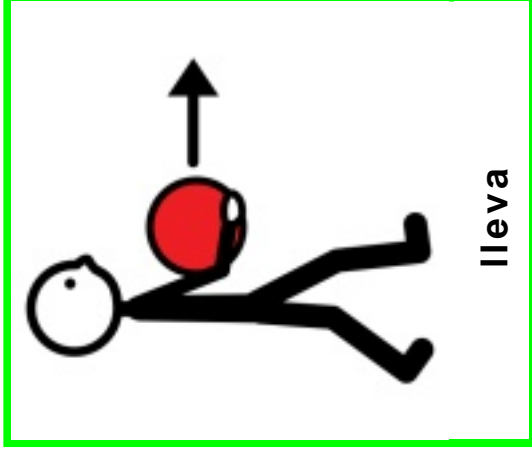
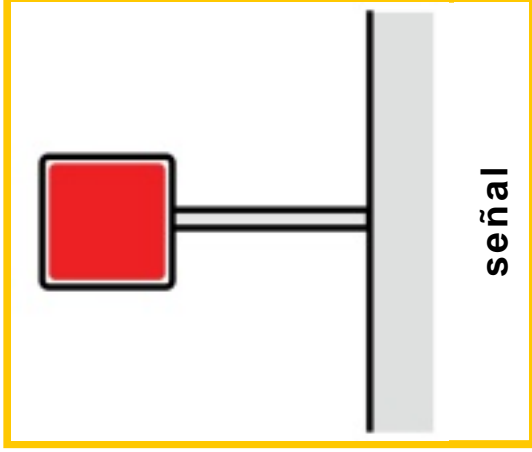
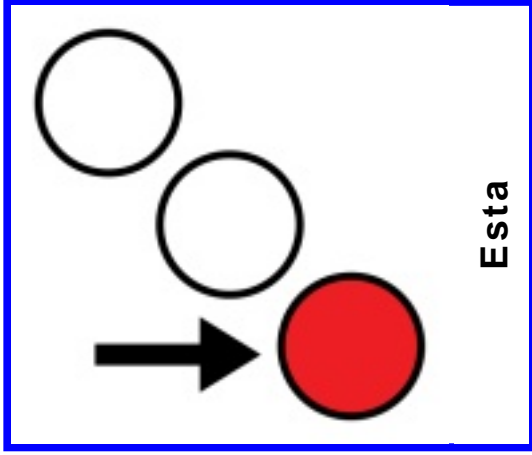



con

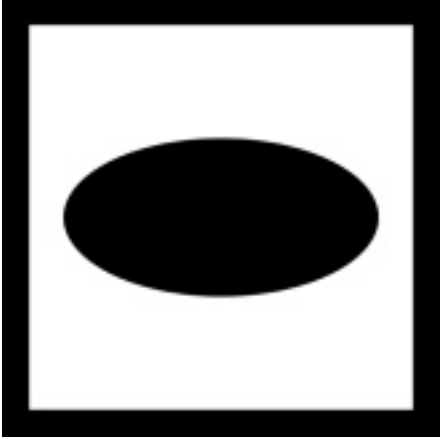

una

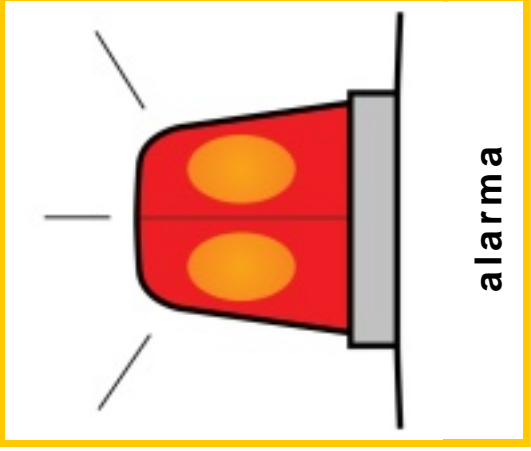

alarma



o

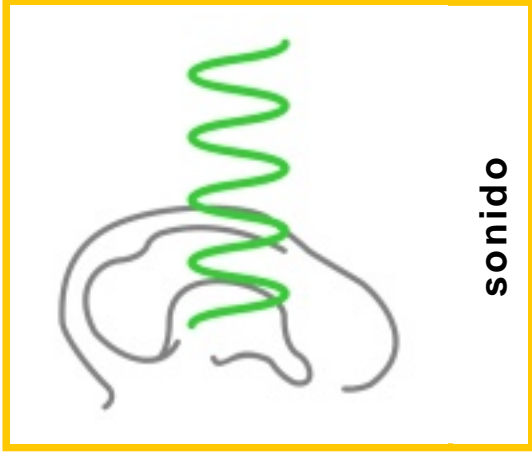

sonido



EI



terremoto

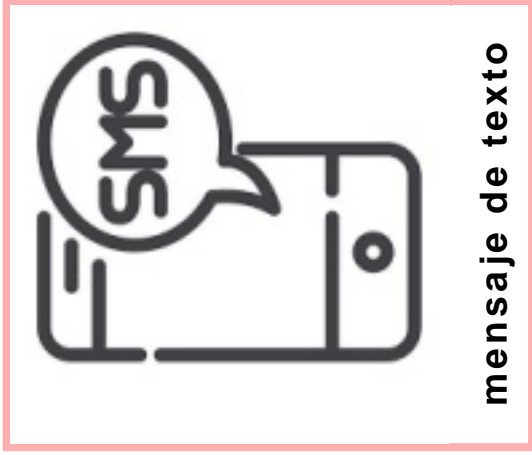

mensaje de texto

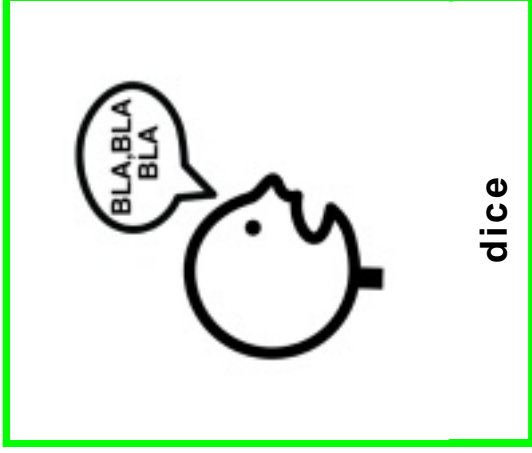

dice

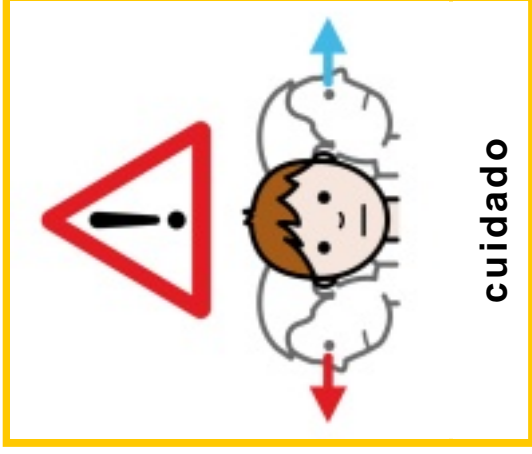

cuidado

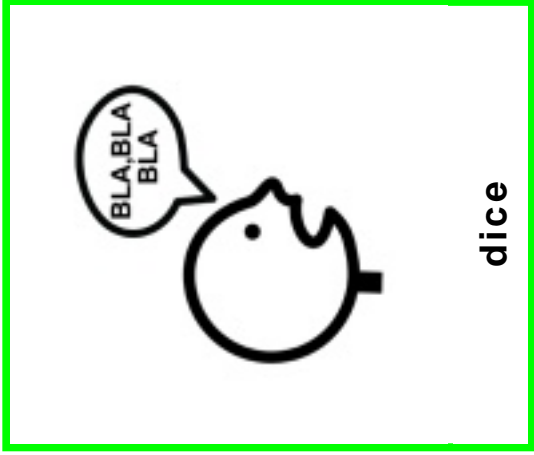

dice

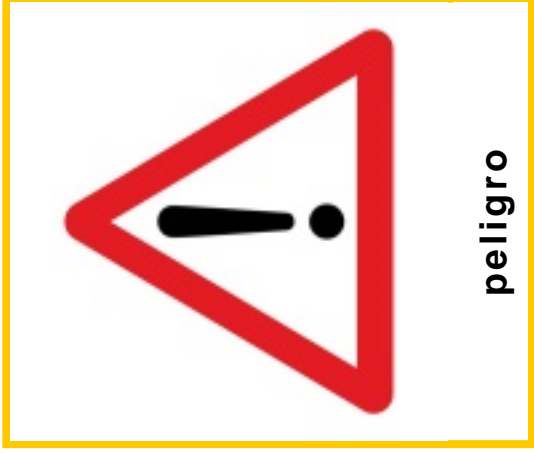

peligro



Tsunami

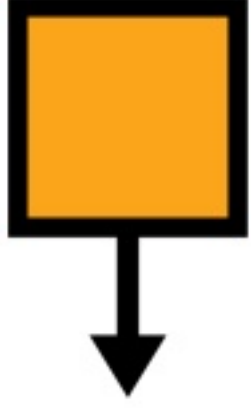

de



EI



sistema de información de emergenci

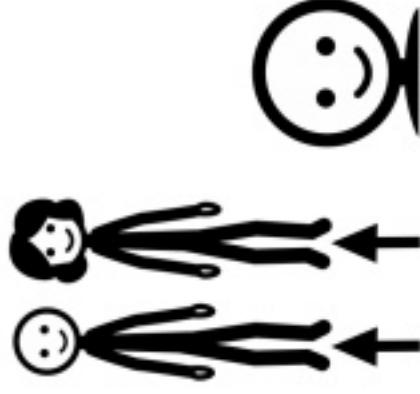

se

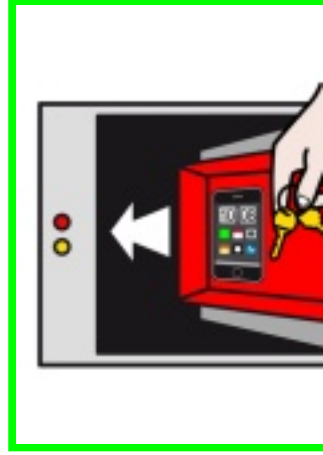

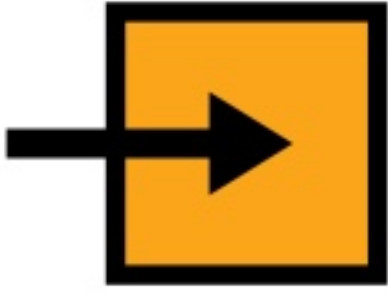

en



el



celular

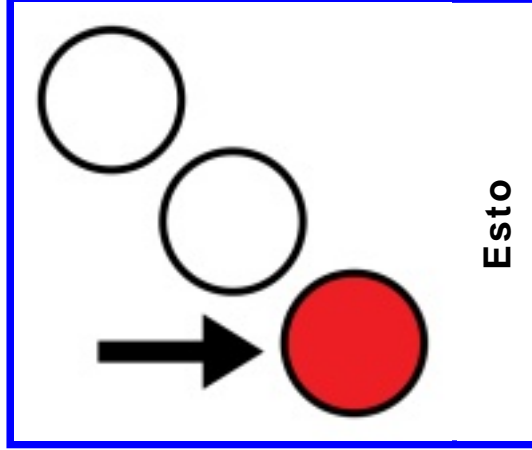

Esto

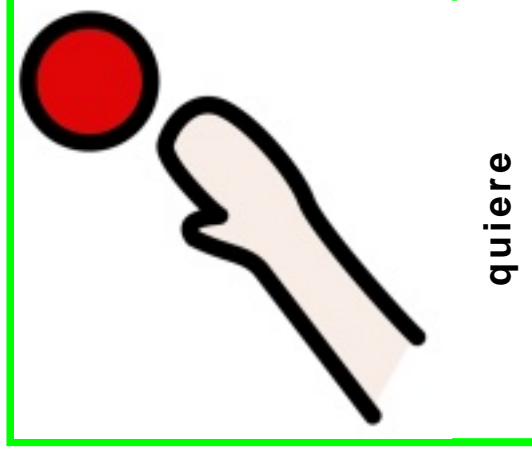

quiere

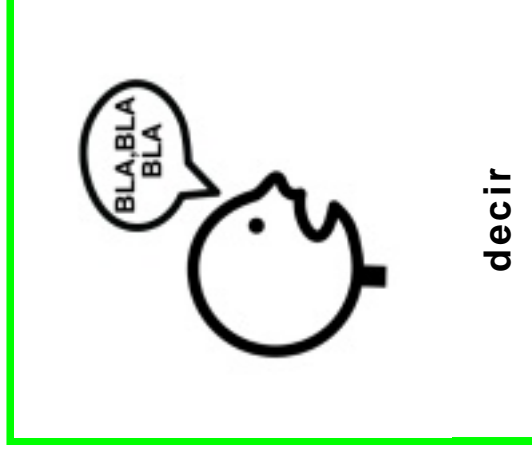

decir



que

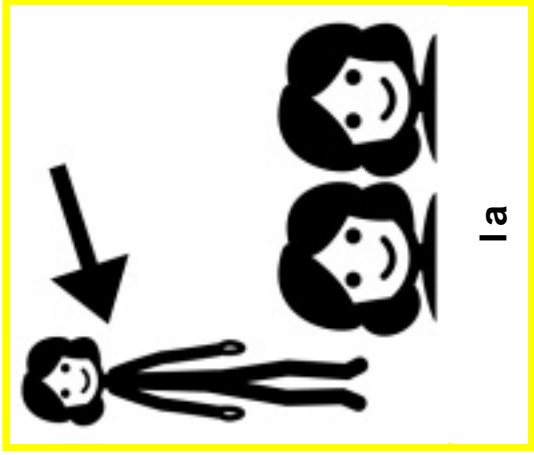

la

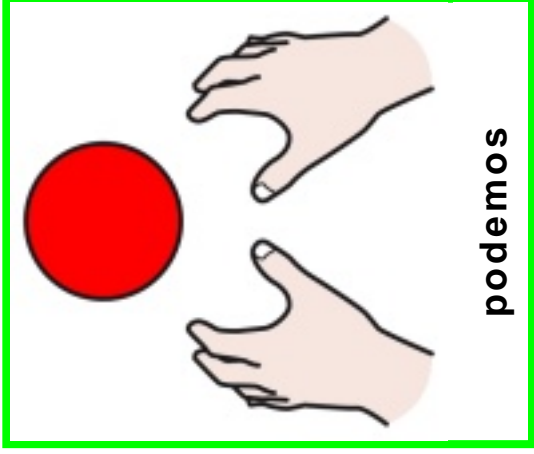

podemos

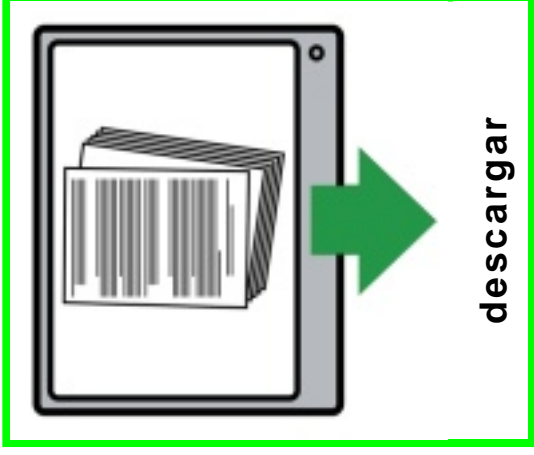

descargar

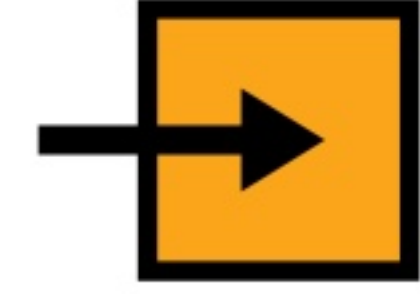

en



el



celular.

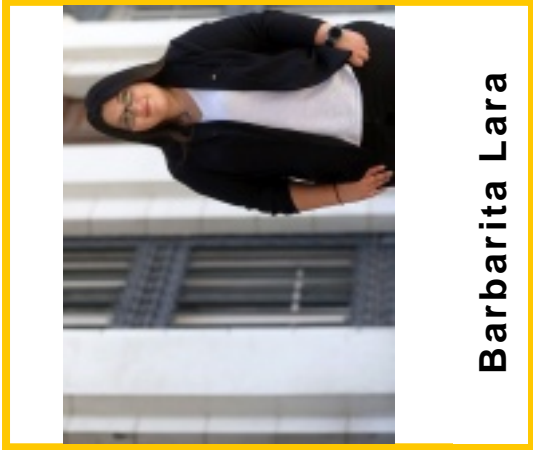

Barbarita Lara

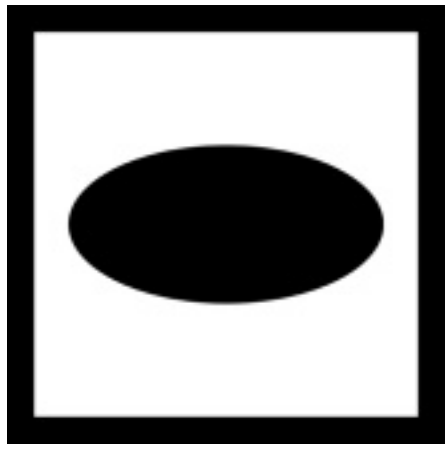

un

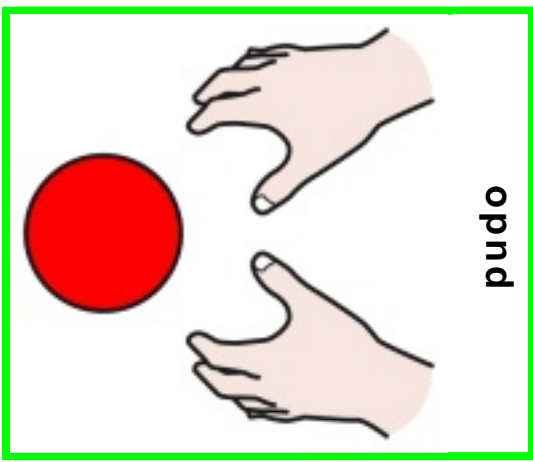

pudo

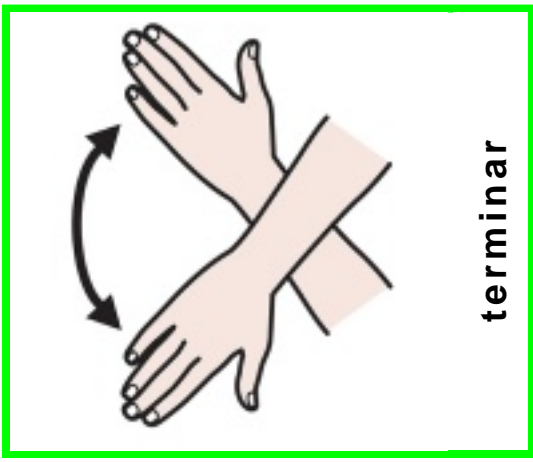

terminar

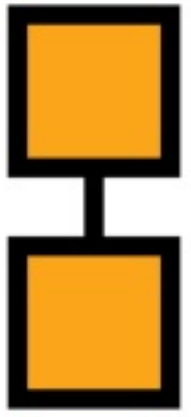

con

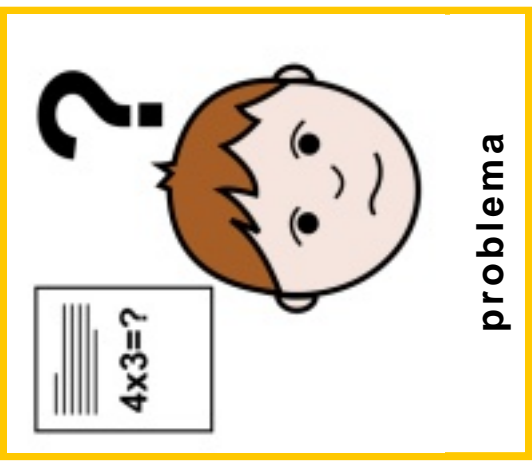

problema



EI

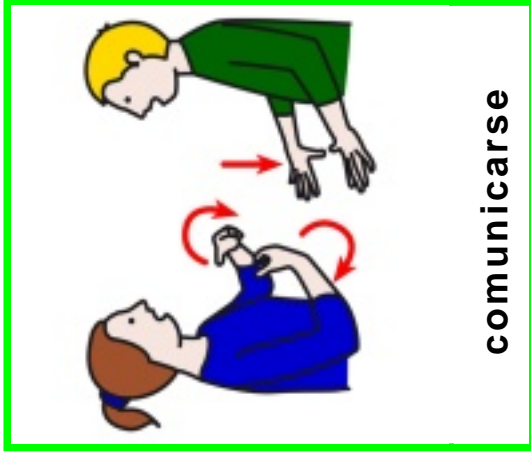

comunicarse

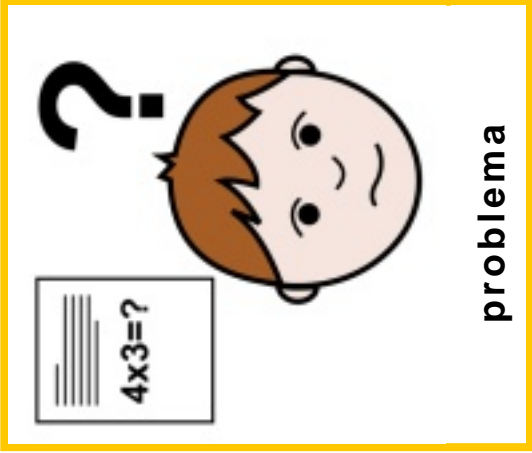

problema

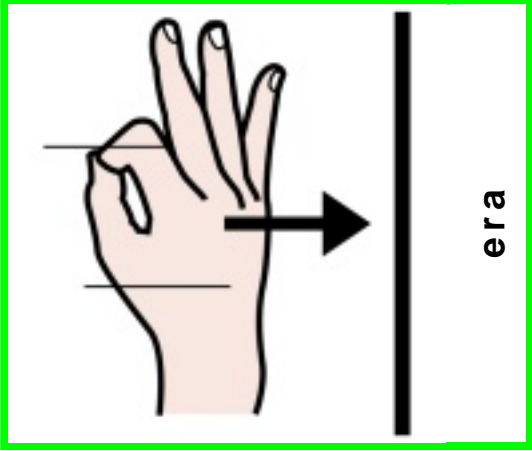

era

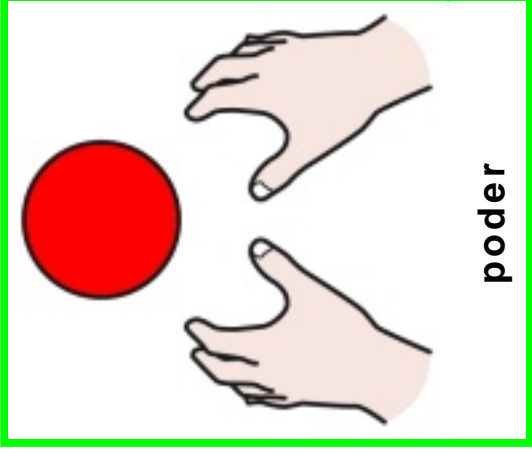

poder

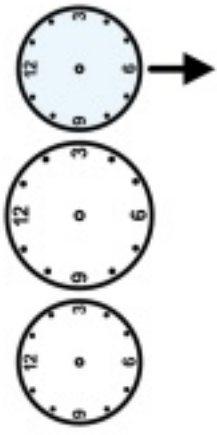

después

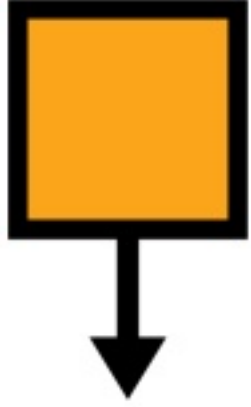

de

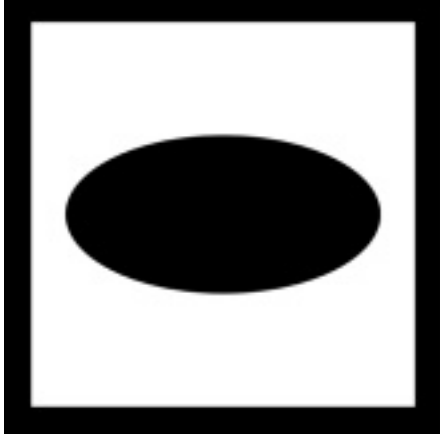

un



EI

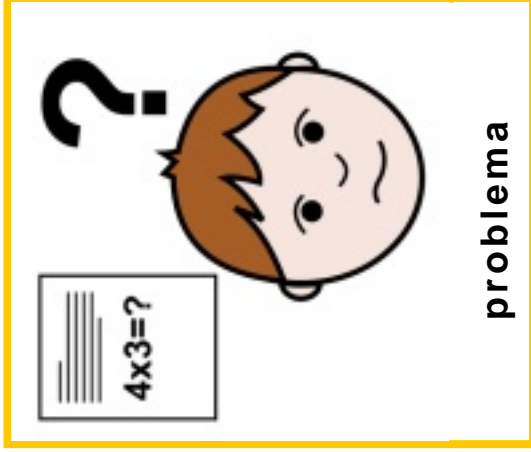

problema

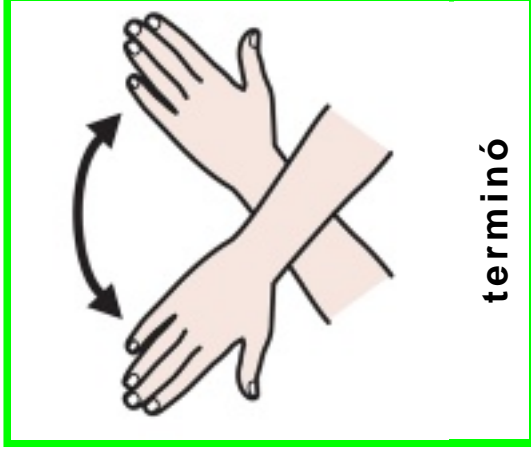

terminó



usando



terremoto

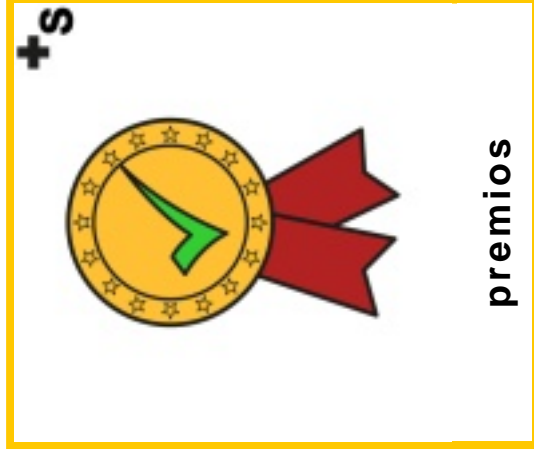
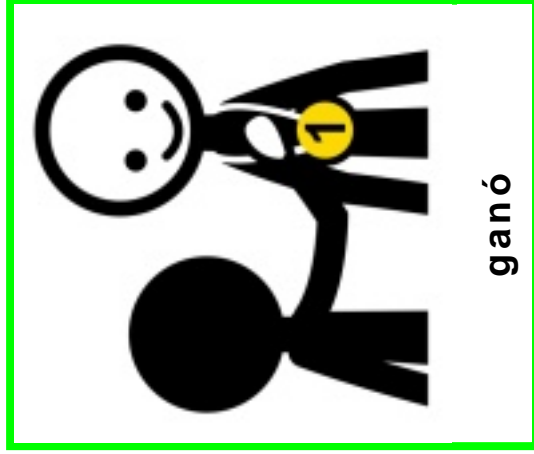
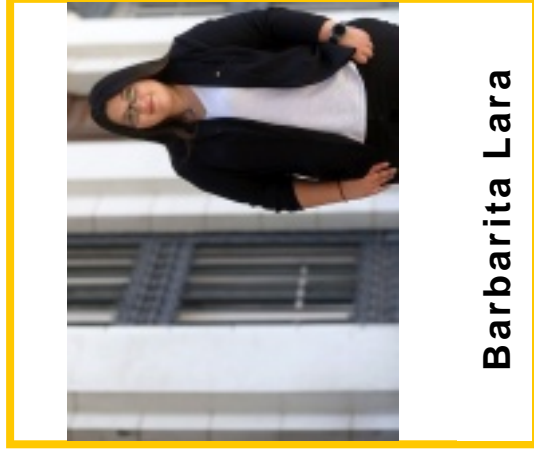
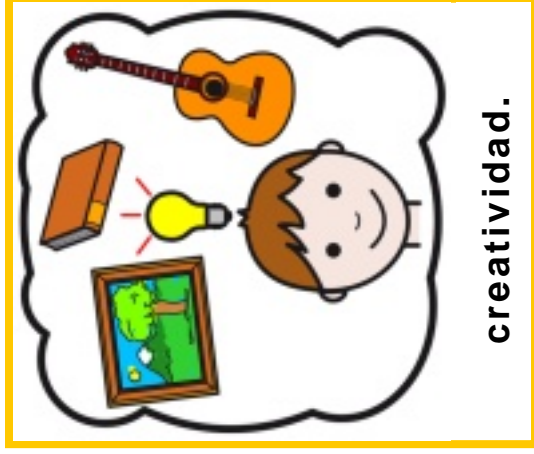
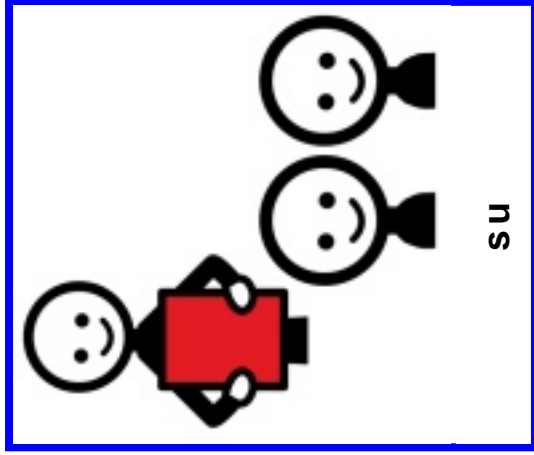

con

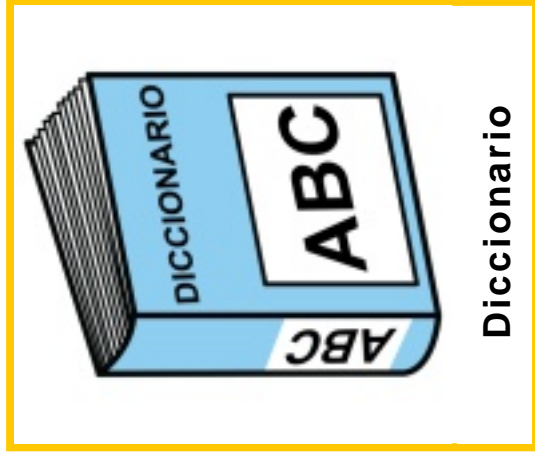
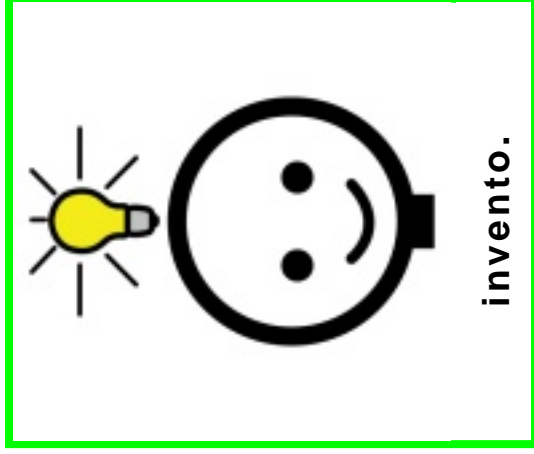
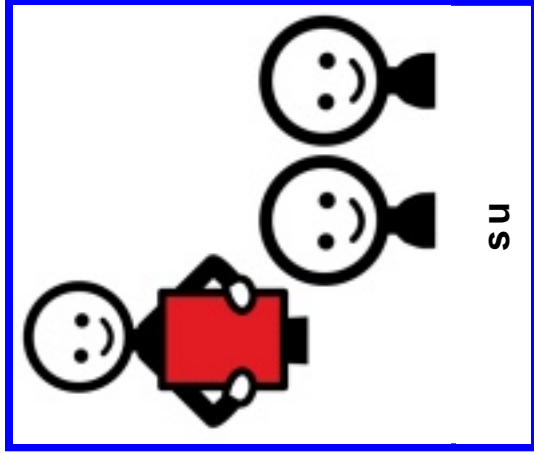

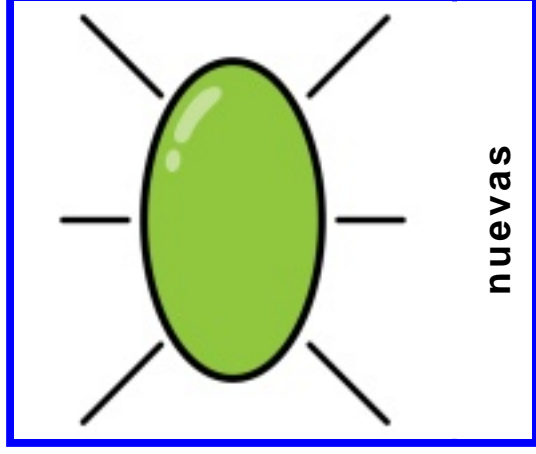
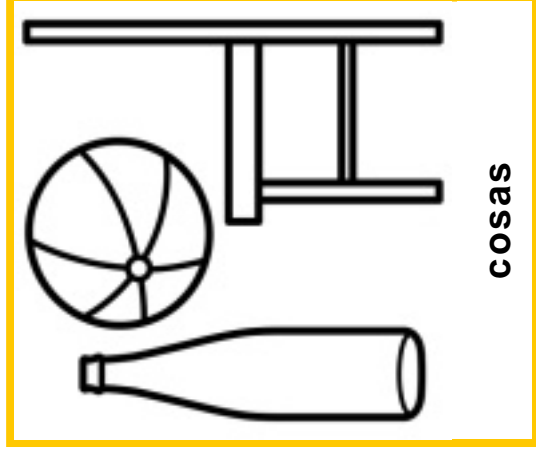
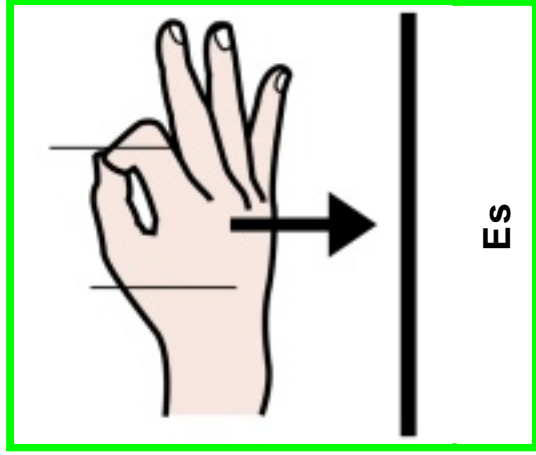
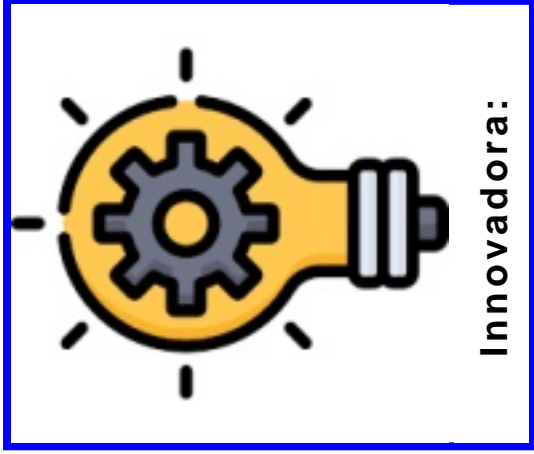



para



el

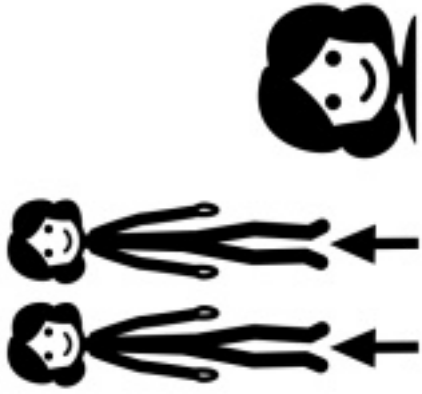

las



celular



personas

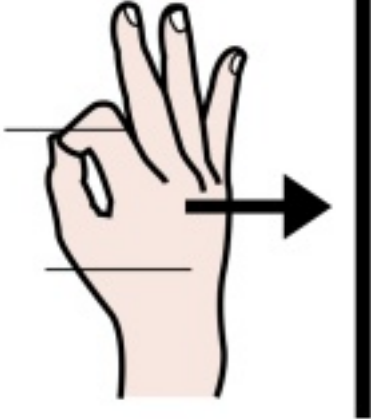

es

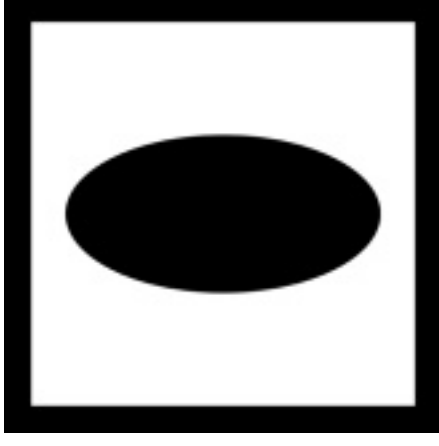

un

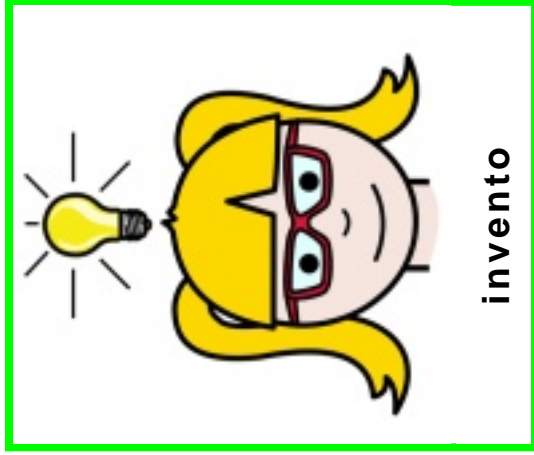

invento

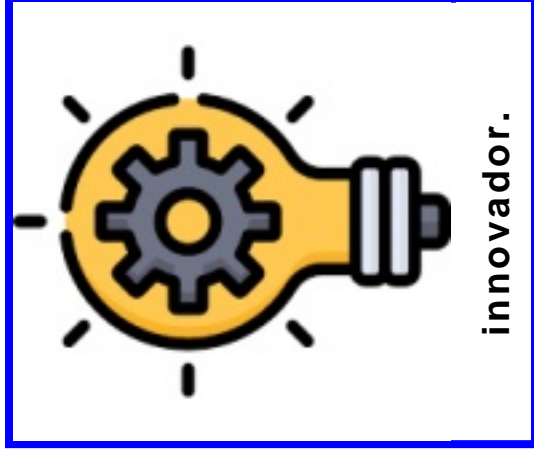

innovador.

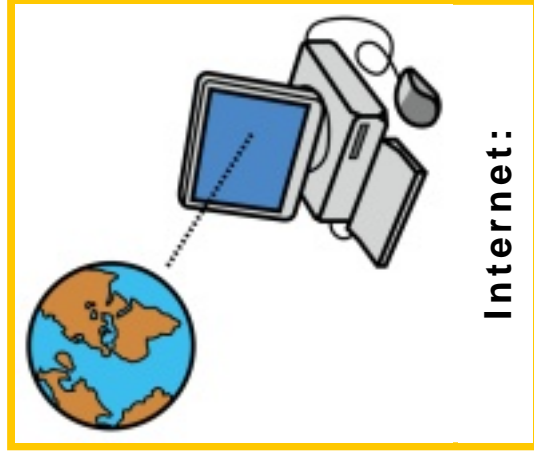

Internet:

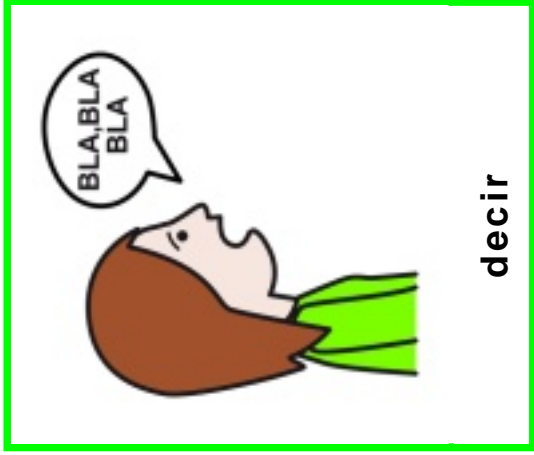
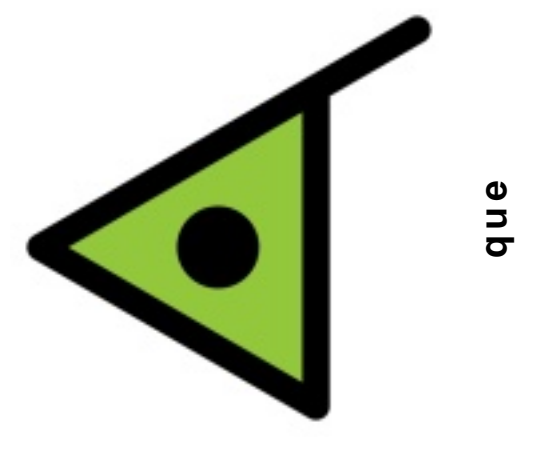
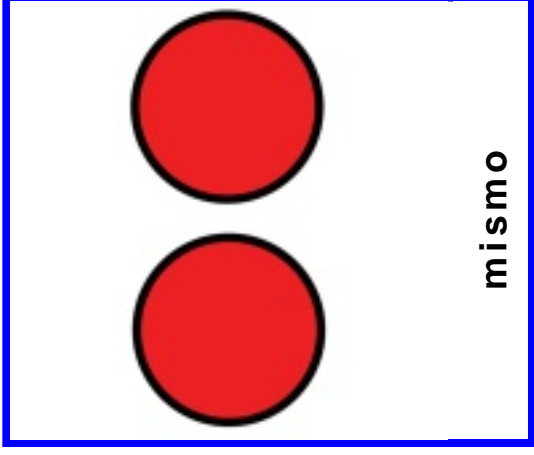
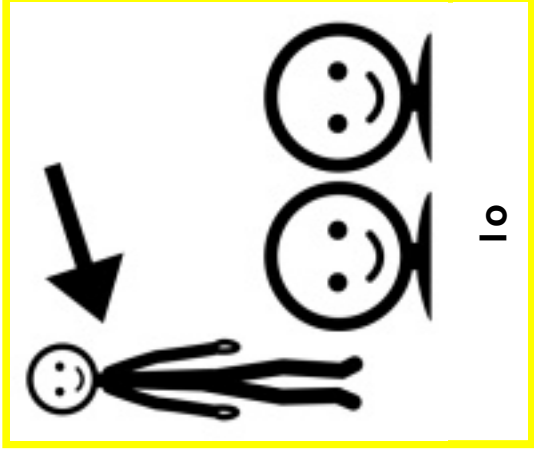
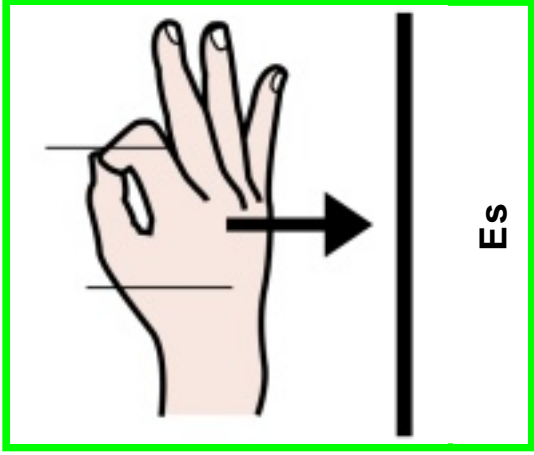

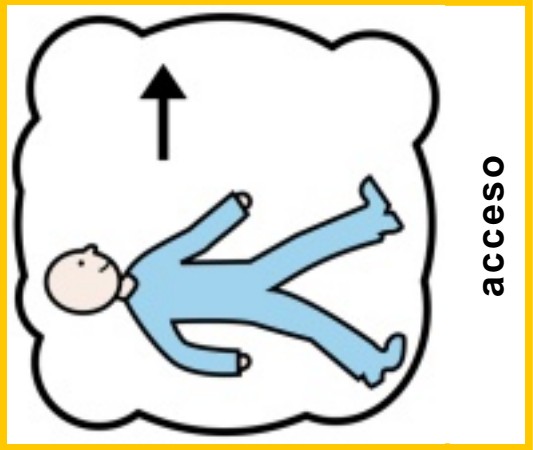

acceso



a



celulares



y

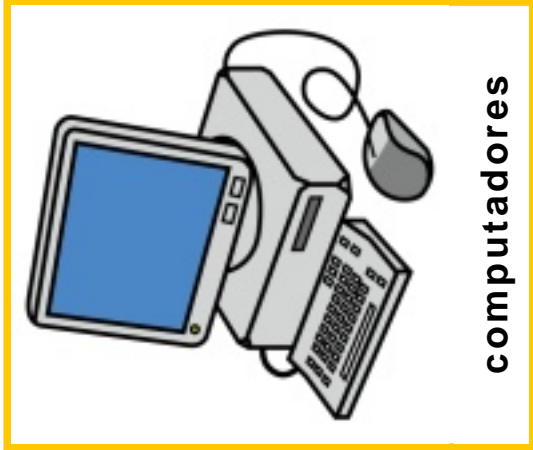

computadores

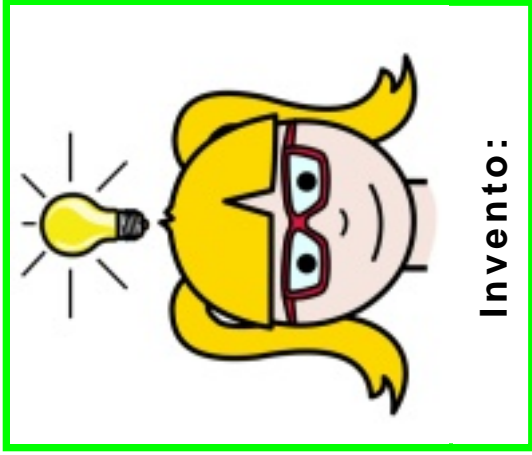

Invento:

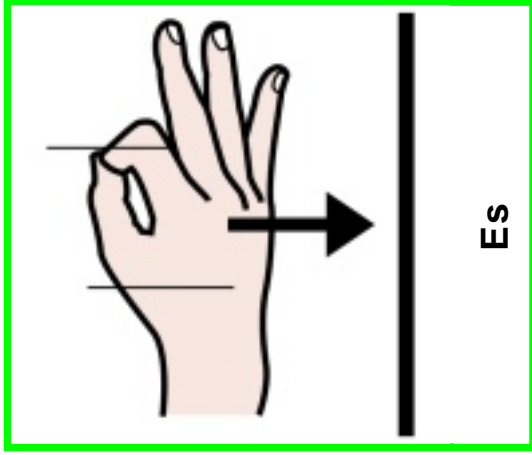

Es

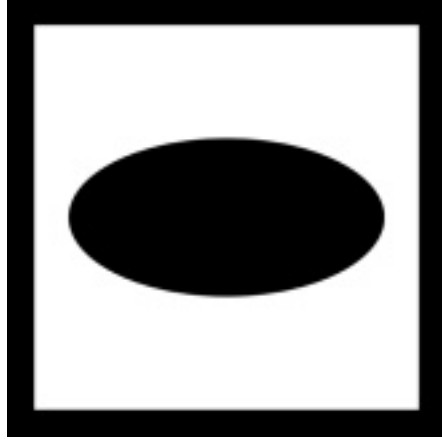

un

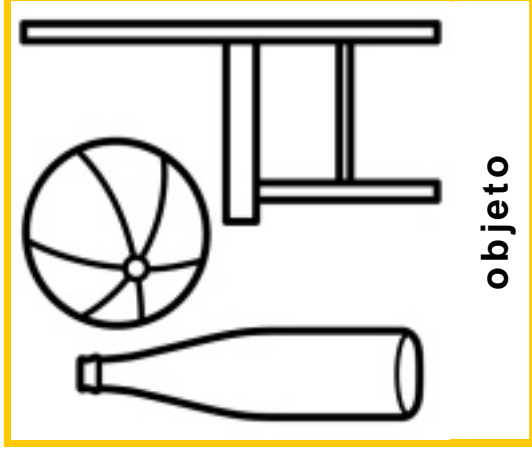

objeto

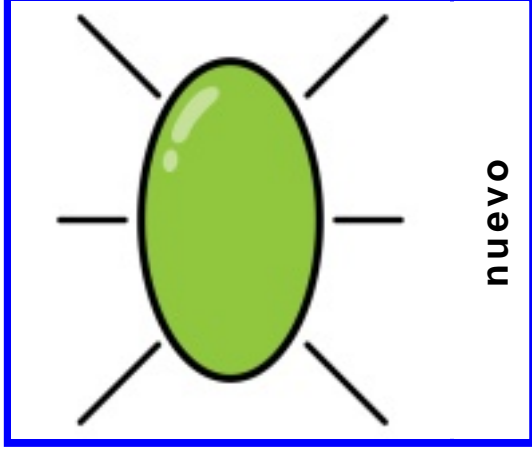

nuevo

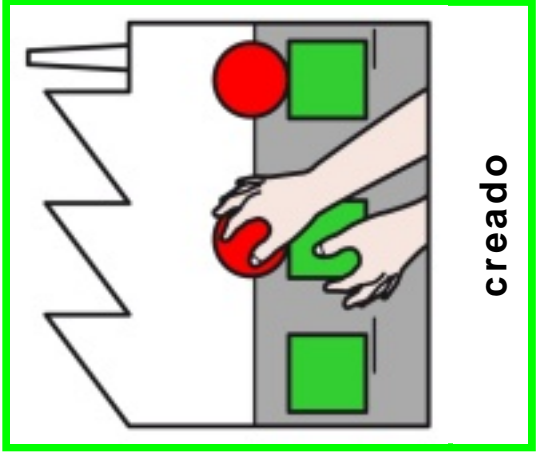

creado



por

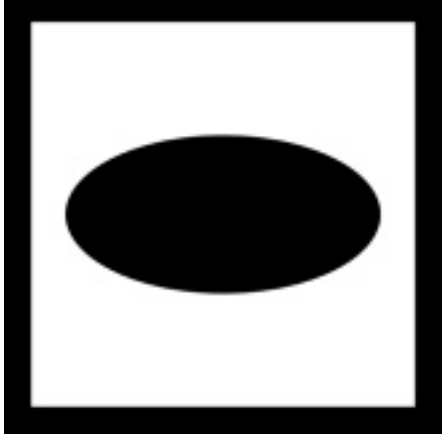

una

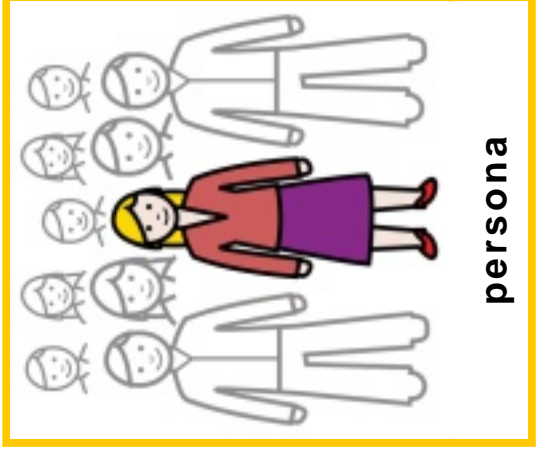

persona

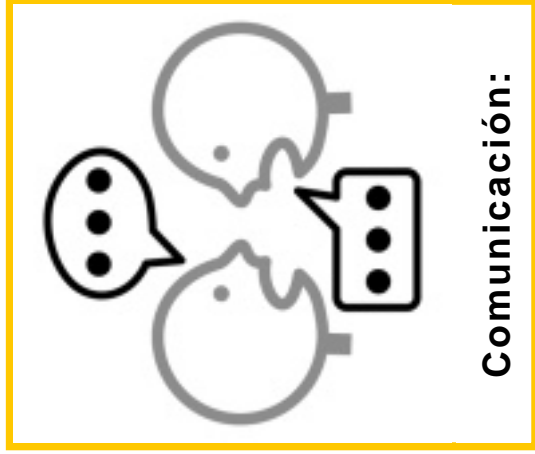

Comunicación:

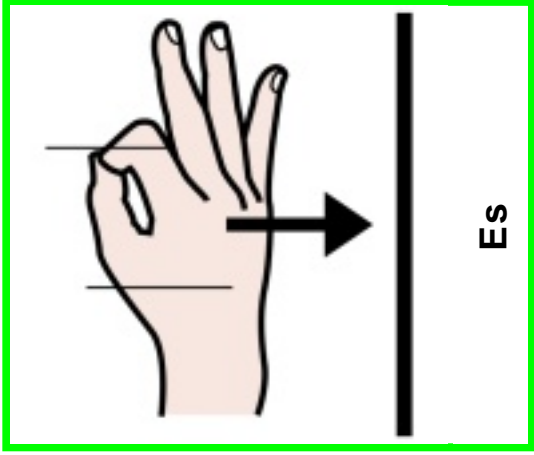

Es

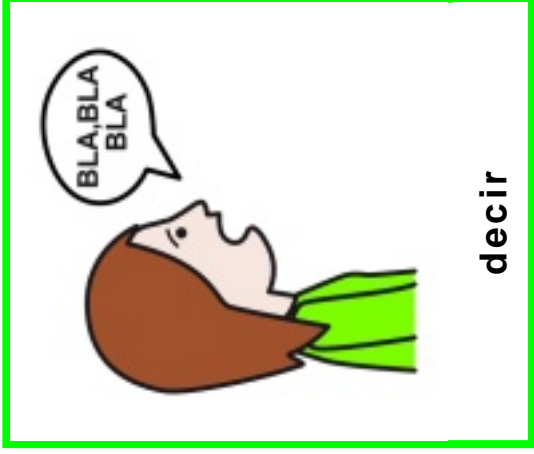

decir

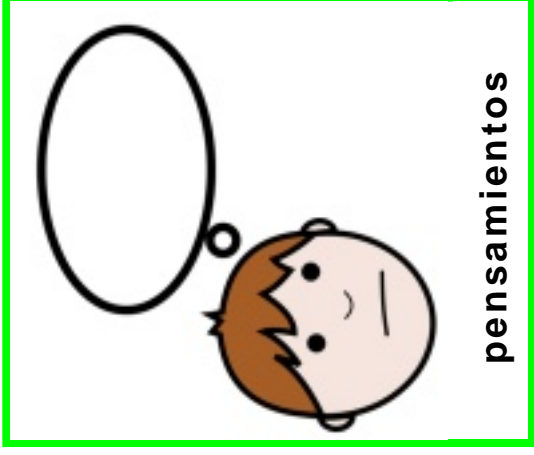

pensamientos

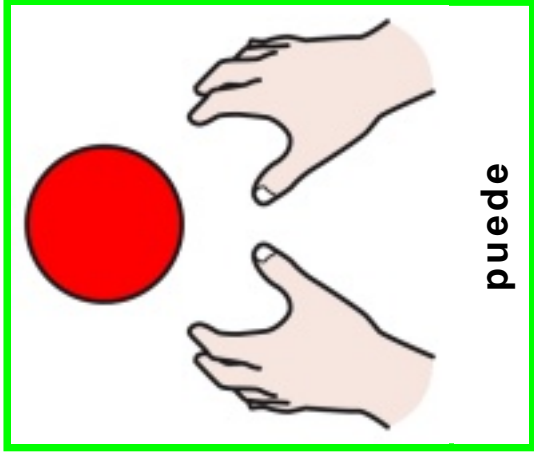

puede

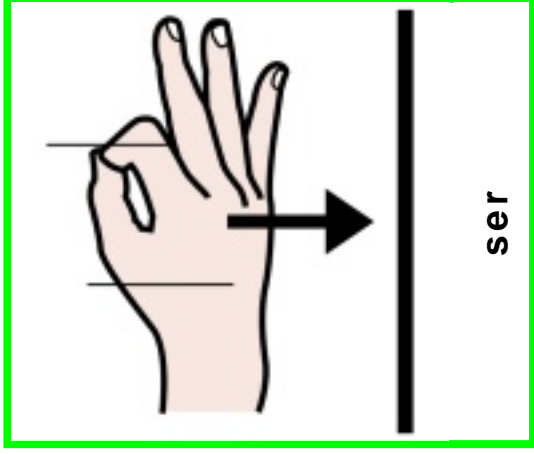

ser



y



de



como

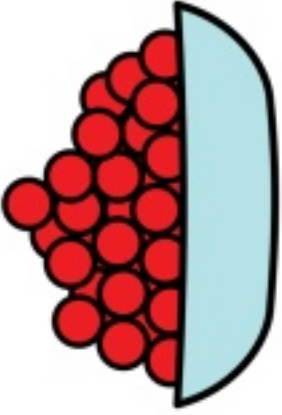

muchas

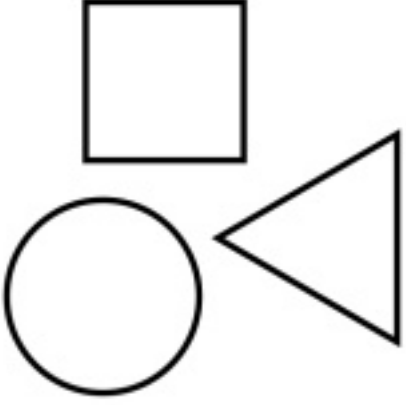

formas



hablar



escribir



dibujar

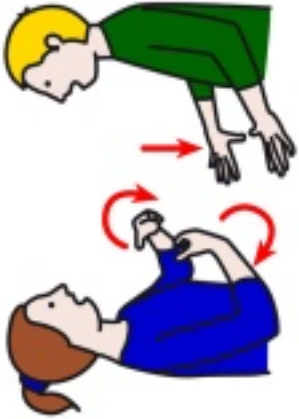

lengua de señas

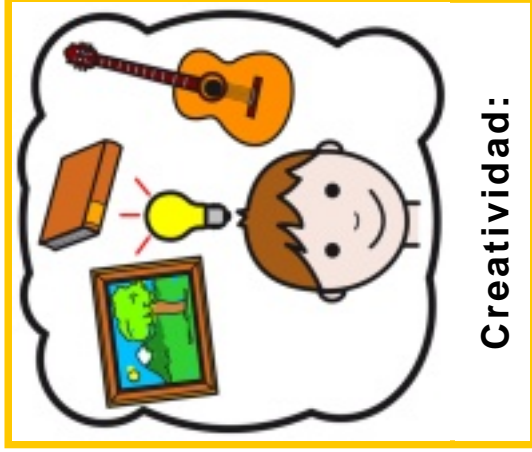

Creatividad:

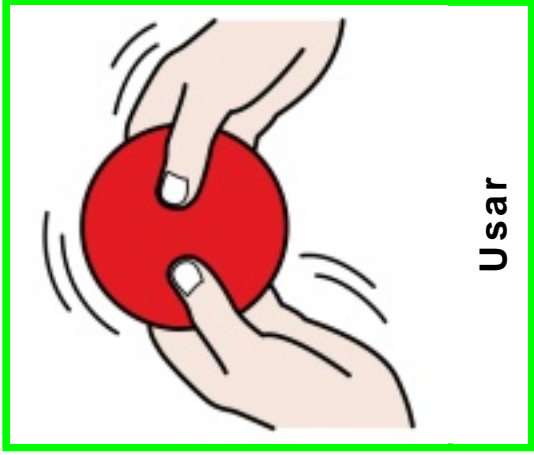

Usar

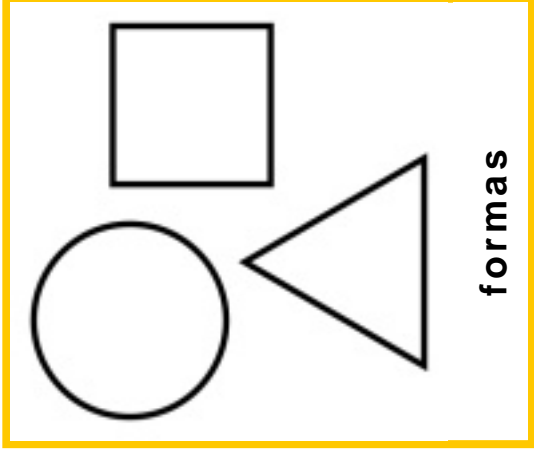

formas

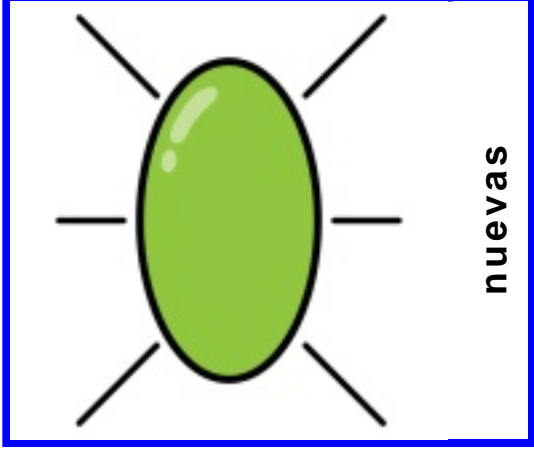

nuevas



y

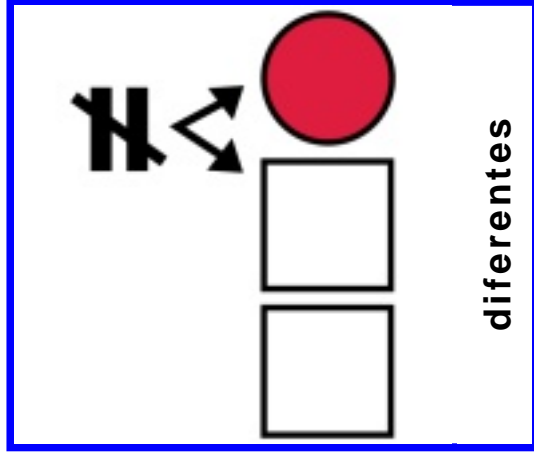

diferentes



para

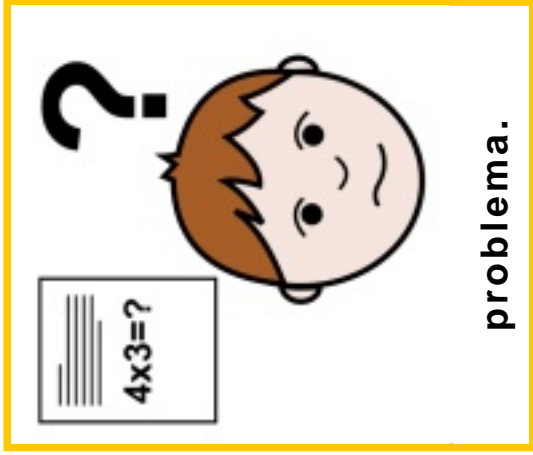

problema.

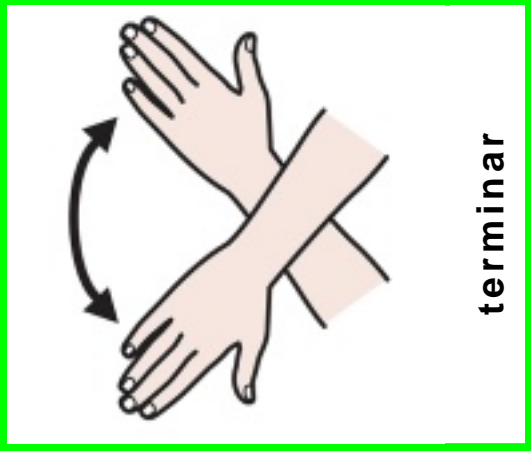

terminar

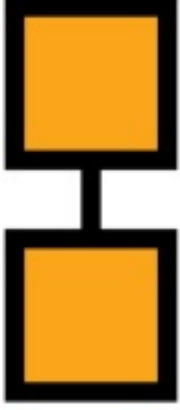

con

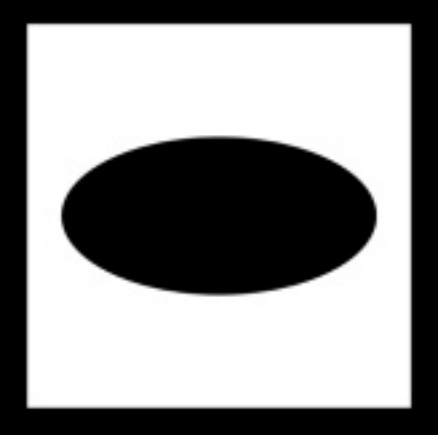

un

